

Manual

Software L-LAS-LT-Scope V5.2

(PC software for Microsoft® Windows 10, Windows 7)

for laser triangulation sensors
(L-LAS-LT-xx-AL and L-LAS-LT-xx-SL Series)

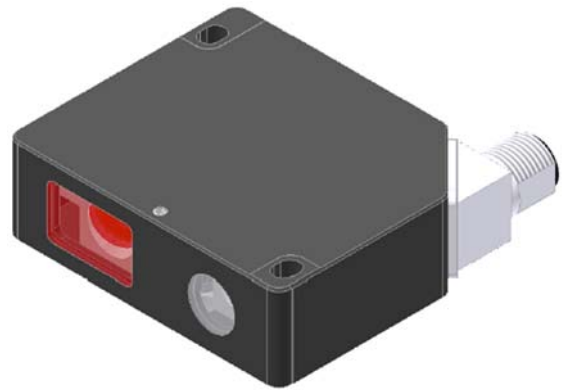

L-LAS-LT-...-AL Series

L-LAS-LT-20-AL
L-LAS-LT-38-AL
L-LAS-LT-50-AL
L-LAS-LT-120-AL
L-LAS-LT-165-AL
L-LAS-LT-250-AL

L-LAS-LT-...-SL Series

L-LAS-LT-30-SL
L-LAS-LT-50-SL
L-LAS-LT-80-SL
L-LAS-LT-180-SL
L-LAS-LT-350-SL
L-LAS-LT-600-SL

0 Contents

0	CONTENTS	2
1	FUNCTIONAL PRINCIPLE: L-LAS-LT TRIANGULATION SENSORS	3
1.1	Technical description	3
2	INSTALLATION OF THE L-LAS-LT-SCOPE SOFTWARE	4
3	FUNCTION ELEMENTS OF THE L-LAS-LT-SCOPE SOFTWARE.....	5
3.1	Short description of the <i>L-LAS-LT-Scope</i> user interface:	5
3.2	General function elements of the <i>L-LAS-LT-Scope</i> software:	6
3.3	PARA1 tab:	8
3.4	PARA2 tab:	12
3.5	CALIBRATION SETTINGS tab:	14
3.6	DATA RECORDER SETTINGS tab:.....	15
3.6.1	Data format of the output file	17
3.7	CONNECTION tab	18
3.7.1	Data transfer through the external RS232 Ethernet adapter:	20
4	WORKING WITH THE L-LAS-LT-SCOPE SOFTWARE.....	21
4.1	Setting the laser operating mode.....	21
4.2	Aid for sensor adjustment, numeric and graphic display elements	22
4.3	Teaching of evaluation range beginning (MRB) and end (MRE).....	24
4.4	Restoring the standard evaluation range.....	25
5	ANNEX	27
5.1	Dimensions / adjustment.....	27
5.2	Laser warning	28
5.3	Function of digital input IN0	29
5.4	Function of digital input IN1	30
5.5	Function of the hardware button at the housing	31
5.6	Connectors.....	33
5.7	RS232 interface protocol	35
5.7.1	Parameter set format	37
5.7.2	RS232 data transfer examples	38

1 Functional principle: L-LAS-LT triangulation sensors

1.1 Technical description

In the laser line sensors of the *L-LAS-LT* series the laser beam of a laser diode ($\lambda=670\text{nm}$, 1mW power, laser class 2) through suitable collimators and apertures is emitted from the optical transmitter unit as a parallel laser beam with homogeneous light distribution. After being reflected from the object surface, the laser light impinges on the CMOS line receiver of the optical receiver unit. This CMOS line comprises many closely adjacent individual receiver elements (pixels) that are arranged in a line. The light quantity of each of these receiver elements that is collected during the integration time can be separately read out as an analog voltage and, after performing analog-digital conversion, can be stored in a data field as a digital value.

Depending on the object distance the laser light that is scattered back from the measuring object (triangulation principle) will only illuminate certain receiver elements (pixels) on the line. Compared to the non-illuminated pixels these pixels will output a considerably higher analog voltage (intensity maxima). By way of suitable software algorithms the areas of the illuminated zones can be determined from the previously stored data field. Since the distance of the pixels on the CMOS line is known, the position and distance of the measuring object can therefore be determined (cf. picture 1).

The micro-controller of the *L-LAS-LT* control unit can be parameterized through the serial RS232 interface by means of a Windows PC software. This allows the setting of various evaluation and operating modes. The housing of the control unit features a TEACH/RESET button for teaching the measuring range. Switching states are visualized by means of two three-color-LEDs, that are integrated in the housing of the *L-LAS-LT* control unit. The control unit has two digital outputs (OUT0, OUT1), the output polarity of which can be set with the software. Two digital inputs (IN0, IN1) make it possible to realize an external TEACH/RESET (IN1) functionality and an external TRIGGER (IN0) functionality through a PLC. In addition the control unit features a high-speed analog output (0 ... 10V) and a current output I-OUT (4...20mA) with 12-bit digital/analog resolution.

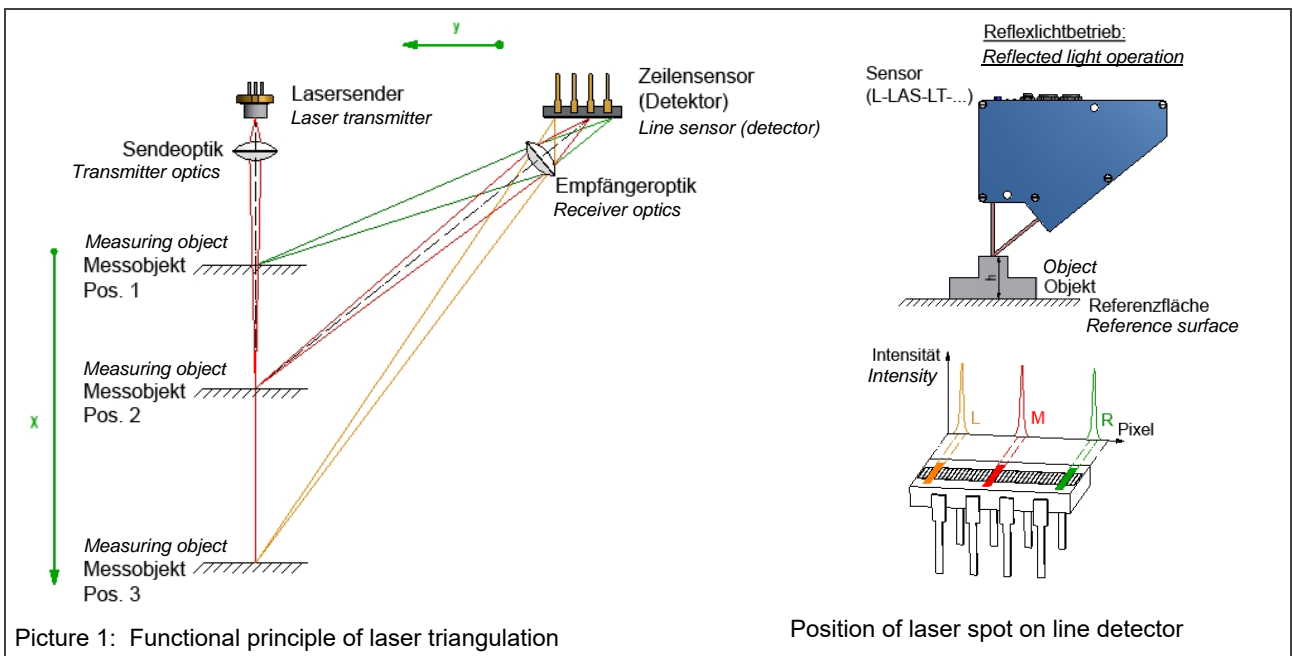



2 Installation of the *L-LAS-LT-Scope* Software

Hardware requirements for successful installation of the *L-LAS-LT-Scope* software:

- 1 GHz Pentium-compatible processor or better.
- CD-ROM or DVD-ROM drive
- Approx. 200 MByte of free hard disk space
- SVGA graphics card with at least 1024x768 pixel resolution and 256 colors or higher.
- Windows® 7 or Windows® 10 operating system
- Free serial RS232 interface or USB port with USB-RS/232 adaptor at the PC

Please install the *L-LAS-LT-Scope* software as described below:

1.  CD-Laufwerk (D:) Insert the installation CD-ROM in your CD-ROM drive. In our example we suppose that this is drive "D".

2.  Start the Windows Explorer and in the folder tree of your CD-ROM drive go to the installation folder D:\Install\
Then start the installation program by double-clicking on the SETUP.EXE symbol.

As an alternative, software installation can also be started by clicking on **START-Run...** and then entering "D:\Install\setup.exe", which must be confirmed by pressing the **OK** button.

3. During the installation process a new program group for the software is created in the Windows Program Manager. In the program group an icon for starting the software is created automatically. When installation is successfully completed the installation program displays "Setup OK".

4. The L-LAS-LT-Scope software can then be started with a mouse click on the respective symbol in the new program group under:
Start >All programs > *L-LAS-LT-Scope V5.2*

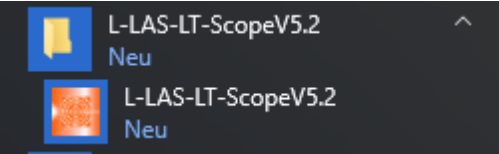

Deinstallation of the *L-LAS-LT-Scope* software:



Programme und Funktionen

Please use the Windows® deinstallation tool to remove the software.

The Windows deinstallation tool can be found under
Start / Settings / Control Panel

3 Function elements of the *L-LAS-LT-Scope* software

3.1 Short description of the *L-LAS-LT-Scope* user interface:

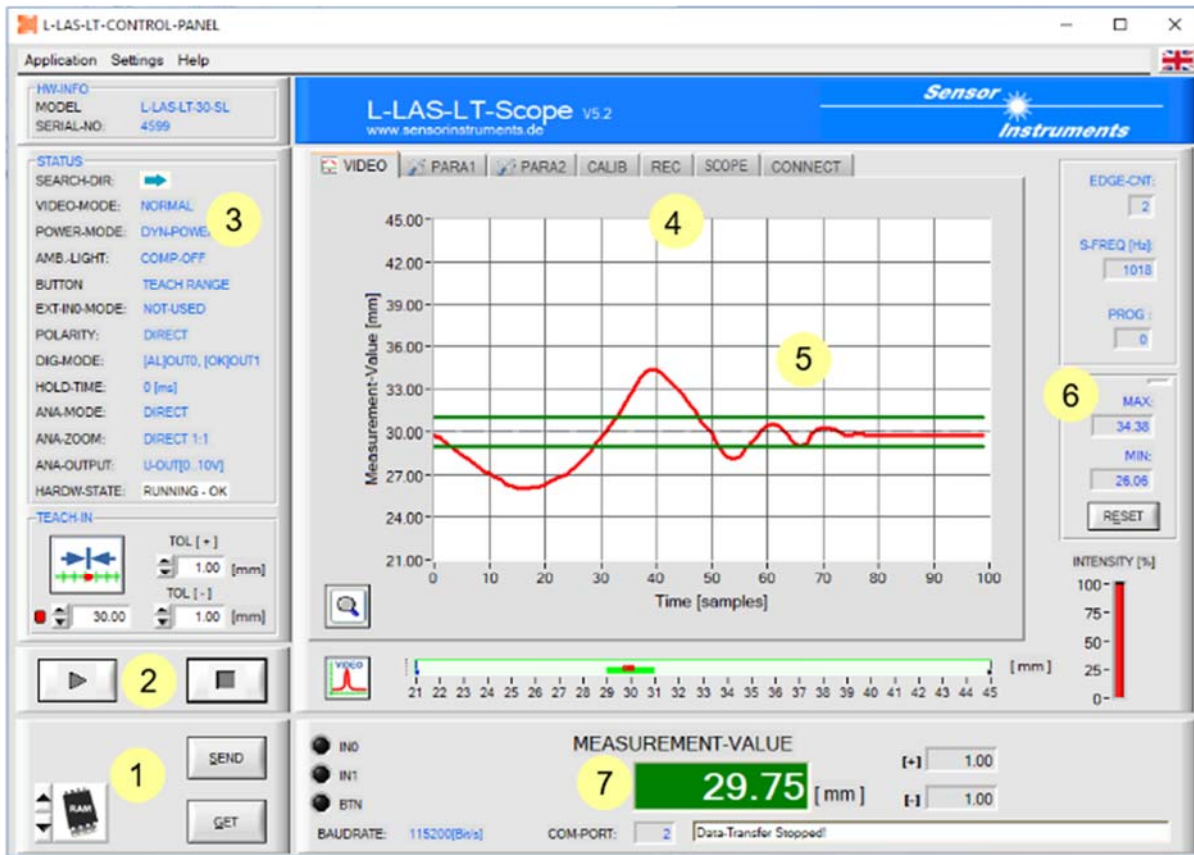

The *L-LAS-LT-Scope* user interface provides a great variety of functions:

- Visualization of measurement data in numeric and graphic output fields.
- Setting the illumination source.
- Setting of the polarity of the digital switching outputs OUT0 and OUT1.
- Selection of a suitable evaluation mode.
- Presetting of setpoint value and tolerance band.
- Saving of parameters to the RAM, EEPROM memory of the control unit, or to a configuration file on the hard disk of the PC.

- 1 Function fields for sending / reading the setting parameters (parameter transfer).
- 2 START / STOP function fields for the RS232 data exchange to the sensor..
- 3 Display of the current operating state at the sensor (evaluation mode, output polarity, ...).
- 4 Tabs to switch between different tab graphic windows.
- 5 Graphic output (display of the temporal measured value profile with teach value and tolerance band).
- 6 Numerical display elements (measuring frequency, number of edges, program number, ...).
- 7 Measured value display in [mm] and graphical representation of the measuring range.

The following chapters provide explanations of the individual control elements of the *L-LAS-LT-Scope* software. Pressing the right mouse button on an individual element will call up a short help text.

3.2 General function elements of the *L-LAS-LT-Scope* software:

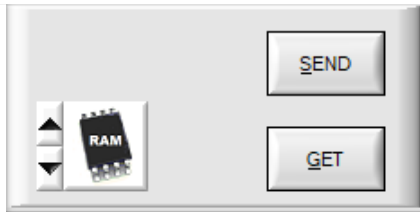

PARAMETER TRANSFER:

This group of function buttons is used for transferring parameters between the PC and the *L-LAS-LT control unit* through the serial RS232 interface..



SEND:

When the SEND button is clicked, the parameters currently set on the user interface are transferred to the *L-LAS-LT control unit*.

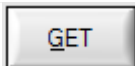

GET:

When the GET button is clicked, the setting parameters are transferred from the *L-LAS-LT control unit* to the PC and are updated on the user interface..

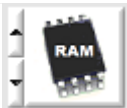

The source or the destination of the data transfer is specified by means of this selection function field:

RAM:

The currently set parameters are written to the volatile RAM memory of the *L-LAS-LT control unit*, or they are read from the RAM.



EEPROM:

The currently set parameters are written to the non-volatile EEPROM memory of the *L-LAS-LT control unit*, or they are read from the EEPROM. Parameters that are saved in the EEPROM will not be lost when the power supply is turned off.



FILE:

When the FILE radio-button is selected, a click on the SEND/GET button opens a new file dialog on the user interface. The current parameters can be written to a freely selectable file on the hard disk of the PC, or parameters can be read from such a file..

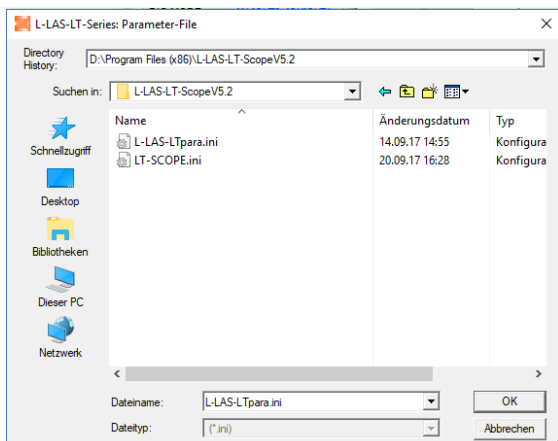

FILE dialog window:

The standard output file for the parameter values has the file name "L-LAS-LTpara.ini".

The output file can be opened e.g. with the standard Windows text editor program "EDITOR"..



START – STOP button:

Data transfer through the serial RS232 interface can be controlled by clicking on these two buttons.

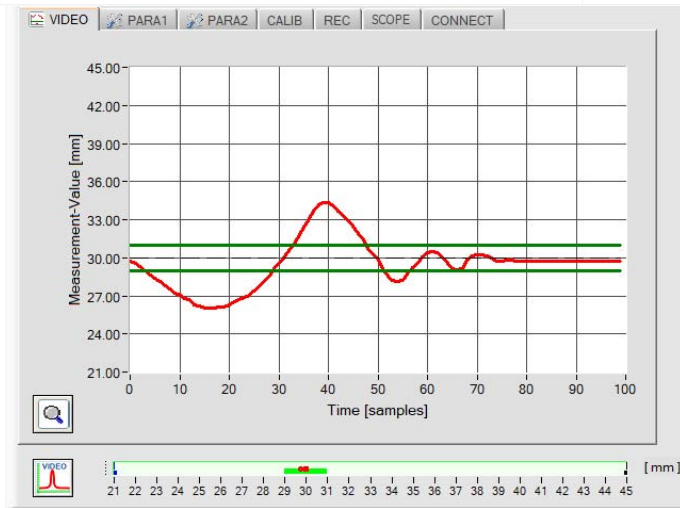

In the **[VIDEO]** tab the current temporal measurement value profile or the video signal of the line sensor is transferred.

Temporal measurement value profile:

Y-axis: Current distance value [mm]

X-axis: Time [scans]

The graphic window shows the temporal profile of the last 100 measurement values (red curve). The tolerance band limits are displayed as green horizontal lines. The current teach value is shown as a black dashed line.

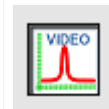
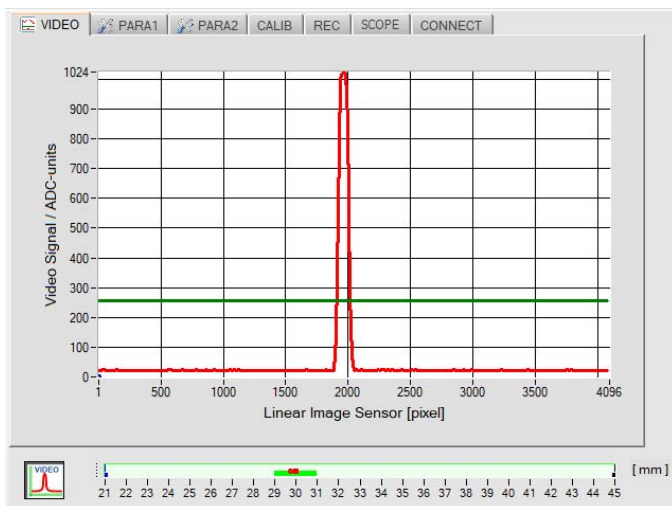

When you click on the Video button, the video image of the line sensor will be transferred.

Intensity curve at the line sensor:

Y-axis: Amplitude at the respective pixel

X-axis: Pixel of the line sensor

This picture shows a typical video response of the line sensor. The laser beam that strikes the object surface is represented as a needle-shaped intensity curve at the receiver. The distance from the measuring object can be calculated from the X-position of the video needle.

3.3 PARA1 tab:

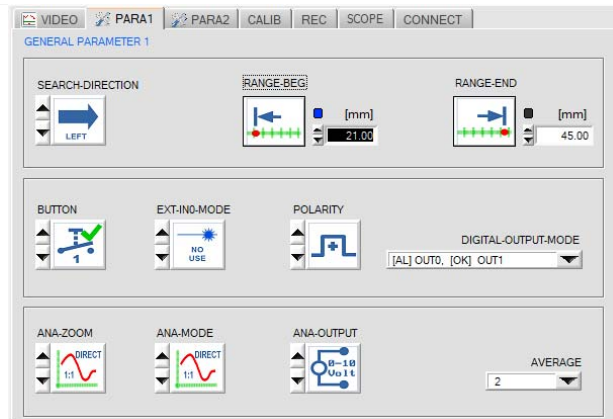

PARA1 tab:

Click on the PARA1 tab to open the GENERAL PARAMETERS 1 window, where you can set various setting and evaluation parameters for the *L-LAS-LT Control Unit*.



SEARCH DIRECTION:

This function element can be used to set the direction for edge searching. A change of the search direction may be helpful if there is interference in the video image.

- LEFT: Search from pixel1 to the last pixel (left to right)
- RIGHT: Search from last pixel to pixel1 (right to left)



EVAL-BEGIN:

Enter a numerical value in the input field or click on the EVAL-BEGIN button to set the beginning of the evaluation range in [mm]. At the beginning of the evaluation range a value of 0V is provided at the analog output.



EVAL-END:

Enter a numerical value in the input field or click on the EVAL-END button to set the end of the evaluation range in [mm]. At the end of the evaluation range a value of 10V is provided at the analog output.



HW BUTTON MODE:

MODE 0 (LOCKED):

The hardware button at the *L-LAS-LT* housing cannot be used to reset the analog output (RESET), teach the position (TEACH-IN), or teach the evaluation range (RANGE-TEACH).



MODE 1: (EVALUATION RANGE):

When the *L-LAS-LT Control Unit* is turned on the hardware button at the *L-LAS-LT* housing is enabled for the first 5 minutes. During this time the button can be used to teach an evaluation range beginning and an evaluation range end. After these 5 minutes the button at the housing will be locked.



MODE 2: (EVALUATION RANGE + TEACH-IN):

When the *L-LAS-LT Control Unit* is turned on the hardware button at the *L-LAS-LT* housing is enabled for the first 5 minutes. During this time the button can be used to teach an evaluation range beginning and an evaluation range end. After these 5 minutes the button at the housing will be locked for the teaching of the evaluation range, but it can still be used for teaching (TEACH-IN) the position and for resetting the analog output.



POLARITY:

This function element is used to set the polarity at digital outputs OUT0 and OUT1.
[+] **DIRECT:** In case of an error the respective digital output is set to +Ub (+24VDC), the LED that visualises the state of the digital output lights up in red.



[-] **INVERSE:** In case of an error the respective digital output is set to GND (0V), the LED that visualises the state of the digital output lights up in red.

EXT-INO MODE:

This list element is used to set the trigger mode at digital input IN0/pin3/green.



NO-USE:

No triggering, the control unit operates continuously.



TRIGG-INO L/H:

External edge-controlled triggering of measurement value evaluation through digital input IN0/pin3/green. A new measurement value is generated with every new low/high edge.



TRIGG-INO HIGH:

External triggering of measurement value evaluation through a high-level (+Ub) at digital input IN0/pin3/green.
New measurement values are generated as long as digital input IN0=HIGH.



LASER ON - IN0 HI

Activation of the laser transmitter unit by a HIGH level at IN0/pin3/green.

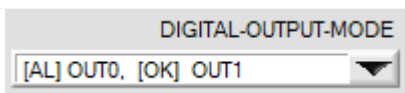

DIGITAL OUTPUT MODE:

This list element is used to set the operating mode of the digital outputs OUT0 and OUT1 at the *L-LAS-LT Control Unit*.

[AL]OUT0, [OK] OUT1

OUT0 outputs the "alarm state",
OUT1 outputs the state "measurement value lies in the set tolerance band".

[-]OUT0, [+] OUT1

OUT0 outputs the state "measurement value < lower tolerance limit",
OUT1 outputs the state "measurement value > upper tolerance limit".

[-]OUT0, [OK] OUT1

OUT0 outputs the state "measurement value < lower tolerance limit",
OUT1 outputs the state "measurement value lies in the set tolerance band".

[+]OUT0, [OK] OUT1

OUT0 outputs the state "measurement value > upper tolerance limit",
OUT1 outputs the state "measurement value lies in the set tolerance band".

ANA-ZOOM MODE: This list element is used to set the zoom mode at analog output AOUT/pin8/red.

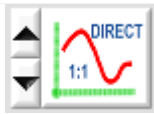

DIRECT 1:1:

At the analog output pin8/red/ the full measuring range of the sensor is provided as a 0 ... 10V voltage swing.

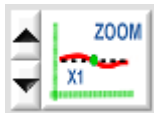

ZOOM X1, ZOOM X2 ... ZOOM X16:

The difference between the current measurement value (pixel) and the teach position (TEACH value in pixel) is provided at the analog output pin8/red/.

At the teach position a value of 5V is provided at the analog output.

If the current measurement value is lower than the teach position, a voltage < 5V is output, if the current measurement value is higher than the teach value, a voltage > 5V is output.

The deviation from the 5V teach position can be amplified with a zoom factor of X2 to X16.

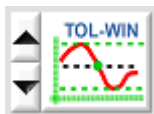
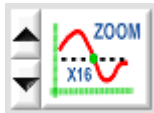

TOL-WIN:

A voltage swing of 10V or 4..20mA over the current tolerance window is provided at the analog output pin8/red/. A value of 5V (or 12mA) is provided at the teach position, at the lower tolerance limit the value at the analog output is 0V (4mA), at the upper tolerance limit 10V (20mA).



ANA OUTPUT:

0-10Volt: Analog voltage output 0...10V /pin8/ M12 PLC connector

4-20mA: Current output 4...20mA /pin7/ M12 PLC connector

ANA MODE:

Function element for selecting the output mode of the analog voltage at the *L-LAS-LT Control Unit* (pin7/pin8 8-pole PLC/POWER female connector). The analog voltage is output in a range from 0 to +10V with a resolution of 12 bit, the current output provides 4...20mA.



DIRECT:

At the analog output pin8/red/ a voltage (0...10V) or a current (4...20mA) is provided proportional to the current measurement value.

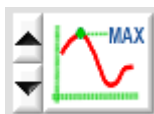

MAXIMA:

The current maximum value is provided at the analog output pin8/red/ (drag pointer principle, resetting by input IN1/pin4/yellow pulse of <750ms length, or by pressing the TEACH/RESET button).

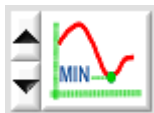

MINIMA:

The current minimum value is provided at the analog output pin8/red/ (drag pointer principle, resetting by input IN1/pin4/yellow pulse of <750ms length, or by pressing the TEACH/RESET button).

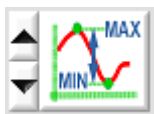

MAX-MIN:

The current difference between maximum and minimum value is provided at the analog output pin8/red/ (drag pointer principle, resetting by input IN1/pin4/yellow pulse of <750ms length, or by pressing the TEACH/RESET button).

AVERAGE

2

AVERAGE:

In this function field the averaging of measurement values can be activated at the *L-LAS-LT Control Unit* with a mouse-click on the respective list item. With every cycle of the main program the current measurement value is stored in a ring memory field, and then the average of these values in the ring memory field is calculated.

The average of the ring memory field is used as the MEASUREMENT_VALUE. With the AVERAGE value the size of the ring memory can be set from 1 to 1024. The measurement value determined after averaging is output at the analog output U-OUT/pin8/red/ and at the current output I-OUT/pin3/green.

S-FREQ [Hz]:

1018

Averaging reduces the switching frequency at the *L-LAS-LT Control Unit* by a factor of 1/AVERAGE.

The current switching frequency is shown in a numeric display element.

3.4 PARA2 tab:

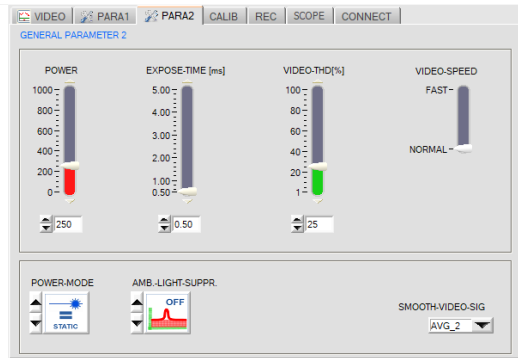

PARA2 tab:

Click on the PARA2 tab to open the GENERAL PARAMETERS 2 window.

In this window various parameters such as laser power, exposure time, and laser operating mode can be set. If necessary, these settings must be adapted to the respective color/brightness of the surface.

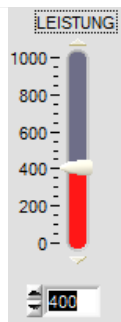

POWER:

In this function field the transmitter power of the laser transmitter unit can be set at the *L-LAS-LT Control Unit* by using the arrows or the slider, or by entering a numerical value in the respective input field.

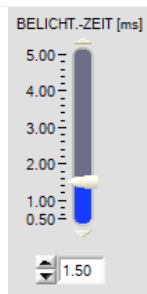

EXPOSURE TIME [ms]:

In this function field the exposure time can be set at the *L-LAS-LT Control Unit* by using the arrows or the slider, or by entering a numerical value in the respective input field.

In case of particularly dark or matt surfaces an increase of the exposure time may help to ensure that enough intensity arrives at the receiver line.

An increase of the exposure time reduces the scan frequency of the sensor (e.g. 0.5ms => 2000Hz, 5ms => 200Hz).

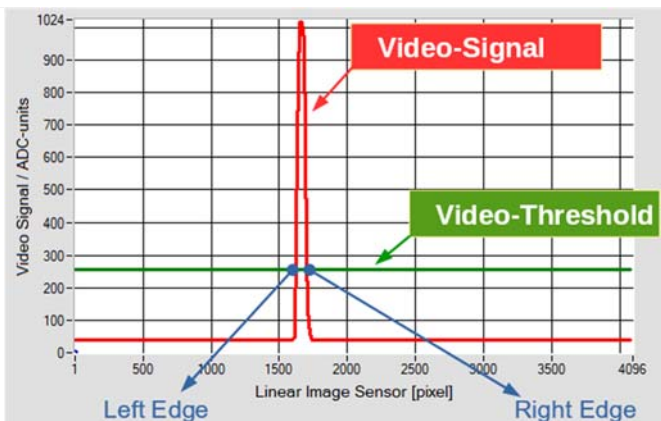
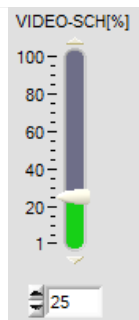

VIDEO THRESHOLD [%]:

With the help of the video threshold (green) the edges (= bright/dark transitions) can be derived from the intensity characteristic of the video signal (red).

For this purpose the intersection points between the video threshold and the video signal are calculated.

The x-value of the respective intersection point is assigned to a pixel on the line receiver.

The measurement value can be calculated from this information and from the known distances of the pixels.



VIDEO SPEED:

This toggle switch is used to set the read speed at the line sensor receiver. A higher read speed will reduce the resolution at the sensor:

NORMAL:	Normal read frequency	▶	Full resolution
FAST:	Fast read frequency	▶	Half resolution



POWER MODE:

In this function field the power control mode for the laser transmitter unit of the *L-LAS-LT Control Unit* can be set.

STATIC:

Static (constant) power at the laser transmitter unit.



DYN-POWER:

The laser power is set dynamically during operation. Dynamic power control attempts to keep the maximum value of the video signal in the control range between 700 and 900 ADC units.



DYN-TIME:

In this mode it is not the laser power at the transmitter unit that is controlled. Here the exposure time at the CMOS line sensor is dynamically adapted. Dynamic exposure time control attempts to keep the maximum value of the video signal in the control range between 700 and 900 ADC units.

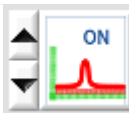

BACKGROUND COMPENSATION:

Background compensation can be activated with this function field. When background compensation is active the laser transmitter is alternately turned on and off. When the laser transmitter is off, the background information (extraneous light) at the receiver line is recorded. The laser transmitter is then turned on, and a normal video image is read at the line sensor. The previously recorded background image is then subtracted from this video image. With this method the interfering constant light content (extraneous light) in the video image can be suppressed. Therefore only the physical effect that is caused by the laser beam is used for evaluation.

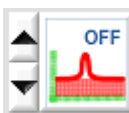

Attention:

If background compensation is activated the switching frequency at the *L-LAS-LT Control Unit* will be reduced by a factor of 4.

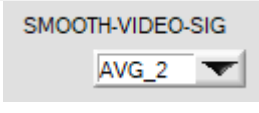

AVERAGING VIDEO SIGNAL:

This list function field can be used to set an averaging value for the video signal. The intensity characteristic of the video signal undergoes "floating averaging" prior to edge searching. This may be helpful for the suppression of interference in the video signal. The size of the ring memory can be set between AVG=1 and AVG=8.

3.5 CALIBRATION SETTINGS tab:

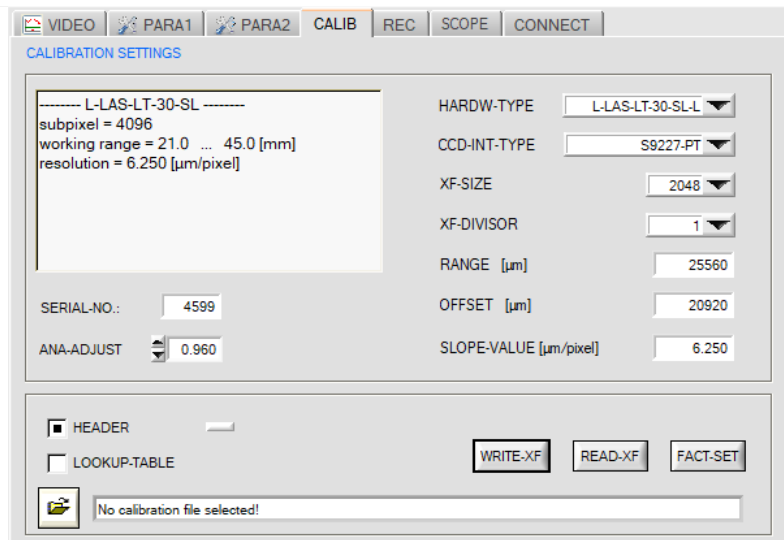

CALIB tab:

Click on the [KALIB] tab to open a window that displays calibration data. When connection is successfully established, these calibration data are automatically transferred from the *L-LAS-LT Control Unit* to the PC. Information about the detected hardware, the working range, and the sensor resolution is displayed in a text field.

In the PC software these factory settings are "greyed out" and can only be changed by the manufacturer.

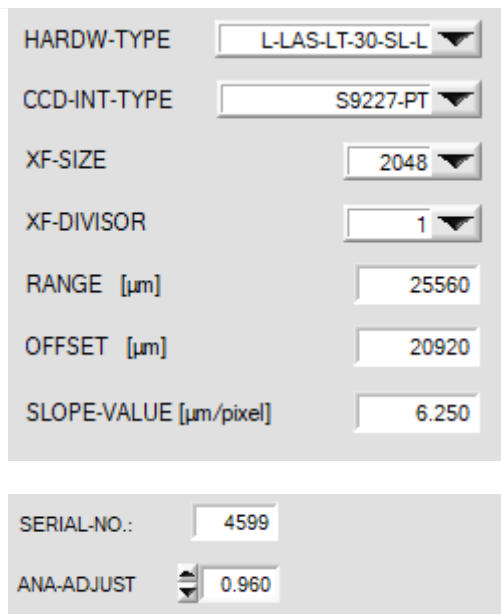

Sensor calibration data:

The sensor-specific factory settings are displayed in several function fields.

HARDW-TYPE: Hardware designation of the sensor
XF-SIZE: Size of the look-up table
XF-DIVISOR: Divisor for conversion of the look-up values.
RANGE [µm]: Measurement range
OFFSET [µm]: Measurement range start
SLOPE VALUE [µm/pixel]: Sensitivity

SERIAL NO: 4 digit serial number
ANA-ADJUST: Calibration 12-bit analog output

3.6 DATA RECORDER SETTINGS tab:

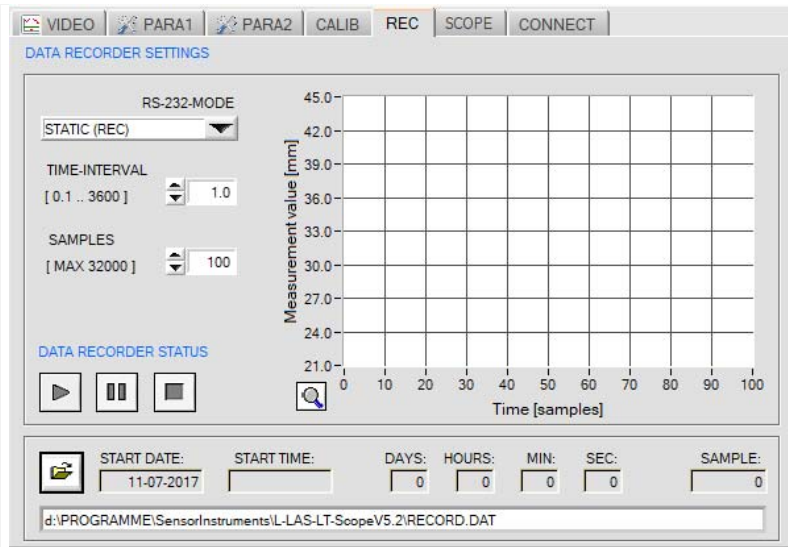

REC tab:

Click on the [REC] tab to open a window that contains settings for the data recorder.

In this window you can make several settings for the data recorder. The data recorder is used to automatically record measurement data in an output file.

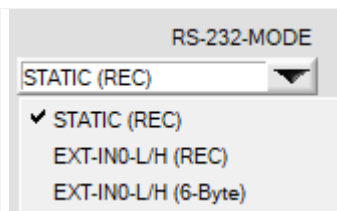

RS232 MODE:

This function field is used to set the operating mode of RS232 data exchange between the PC (PLC) and the *L-LAS-LT Control Unit*.

STATIC (REC):

The sensor does not automatically send measurement data through the RS-232 interface. Every individual data transfer is started by the PC (PLC) with command no. 18. Upon this request the sensor sends a single data frame (36 bytes) to the PC (PLC).

EXT-IN0 L/H (REC):

A single data frame (36 bytes) is automatically sent to the PC (PLC) at every LOW/HIGH edge at digital input IN0/pin3/green.

EXTI-IN0 L/H (6-BYTE):

Cannot be used with the data recorder!

The current measurement value in micrometres is sent with a 6-byte data frame to the RS232 female connector at every LOW/HIGH edge at digital input IN0/pin3/green.

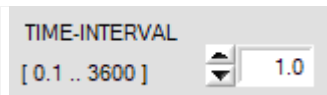

TIME-INTERVAL [s]:

This numeric input field can be used to set a time interval in seconds. When this time interval is over, the PC software automatically requests measurement data from the sensor (command 18). The PC (PLC) waits until the complete data frame (36 bytes) from the sensor has arrived in the input buffer of the serial interface of the PC (PLC). Then the PC (PLC) saves the new measurement data in an output file on the hard disk.

Minimum value: 0.1 [s], maximum value 3600[s] = 1 hour.



SAMPLES:

Numeric input field for presetting the maximum number of measurement values that should be saved. The value range is 10 to 32000.

NUMERIC DISPLAY of the data recorder:

Numeric display fields providing information about the start date and start time of the data recorder. These displays only are updated when the START button is pressed!

DATA RECORDER STATUS:



START:
Click on the START button to automatically start data recording.



PAUSE:
Click on the PAUSE button to interrupt the ongoing graphic output. In the graphic window you can then look at the already recorded data.

The PAUSE button does not interrupt ongoing data recording!



STOP:
Click on the STOP button to stop the ongoing data exchange between PC (PLC) and sensor. The STOP button can be used to stop the process of recording before the maximum number that is preset in the SAMPLES field has been reached.

GRAPHIC DISPLAY of the data recorder:

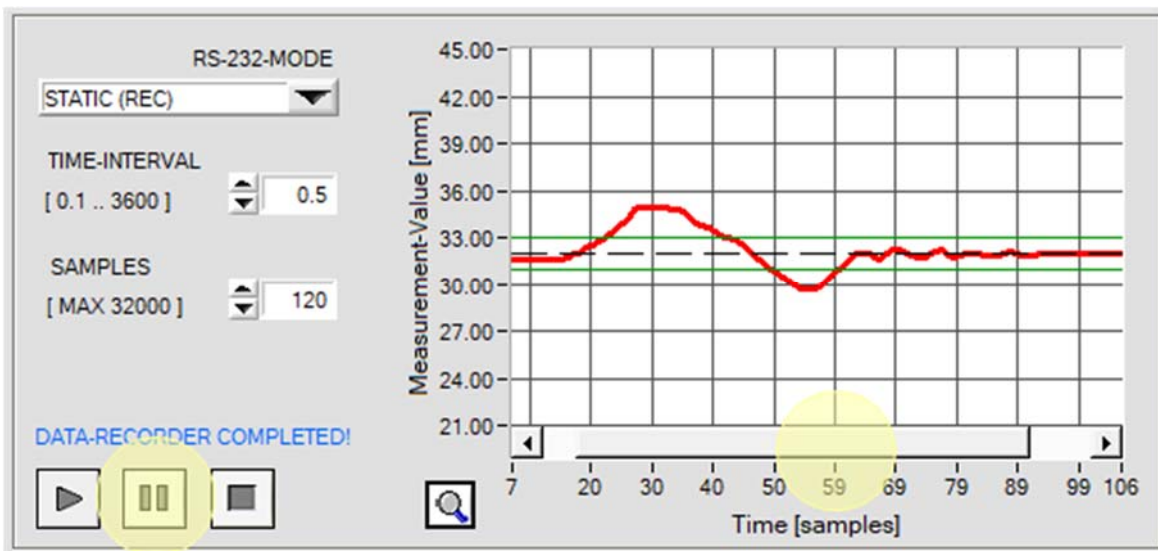

After the START of data recording the temporal measurement value profile is shown as a red curve. The setpoint value is displayed as a black dashed line. The tolerance band around the setpoint value is represented by green lines. The graphic display shows the last 100 measurement values. If you wish to see previously recorded values, click on the PAUSE button. A scroll bar will appear in the graphic display and can be used to scroll to previously recorded values. During this PAUSE time data transfer and saving in the output file are not interrupted but continue to run in the background.

3.6.1 Data format of the output file

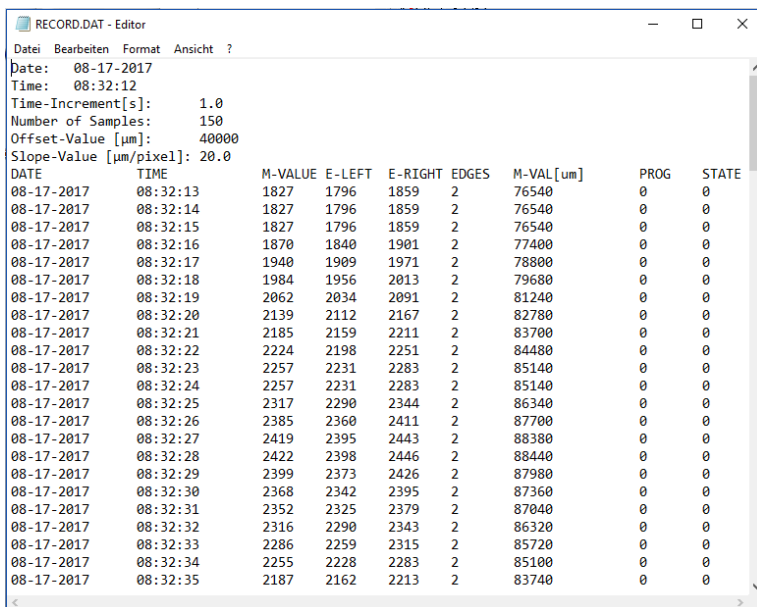
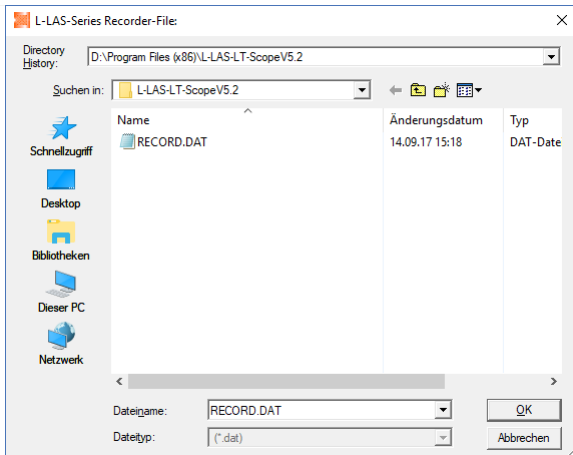

FILE button

Click on the FILE button to open a new dialog window where you can enter the file name and set the directory for the output file.

The currently selected directory and the file name of the output file are shown in a text display under the FILE button.



RECORD.DAT
 DAT-Datei
 7,37 KB

The output file of the data recorder consists of 7 header lines, followed by the actual measurement data.

The measurement data are written to the output file line-by-line. Each line comprises 9 columns that are separated from each other by a TAB control character.

The output file can be opened with a simple text editor or a spreadsheet program (e.g. Microsoft EXCEL).

1. Column := DATE: Date of measurement value acquisition
2. Column := TIME: Time of measurement value acquisition
3. Column := M-VALUE: Measurement value (pixel)
4. Column := E-LEFT: Pixel position of left edge at video peak
5. Column := E-RIGHT: Pixel position of right edge at video peak
6. Column := EDGES: Number of detected edges
7. Column := M-VAL[um]: Measurement value in micrometres
8. Column := PROG: Program number
9. Column := STATE: System state (0 = OK)

3.7 CONNECTION tab

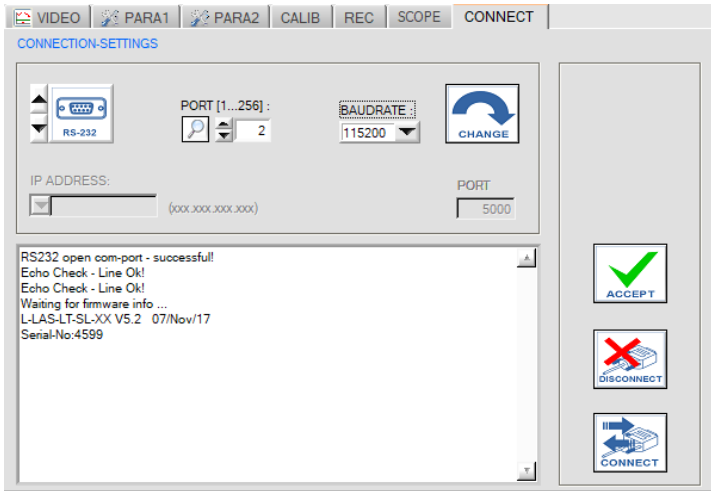

CONNECTION tab:

Click on this tab to open the CONNECTION SETTINGS window, where you can set various parameters for data exchange through the serial RS232 interface.

Basically the following default values are used for communication:

- Standard RS232 serial interface, no hardware handshake
- 3-wire-connection: GND, TXD, RXD
- Baudrates from 9600Baud up to 115200Baud
- 8 DATA bits, 0 PARITY bit, 1 STOP bit
- Highest-order byte first (MSB first).



CONNECT:

When you click on this button, the system attempts to establish a connection to the sensor with the set communication parameters. Feedback about the progress of connection establishment is shown in the status display field.



DISCONNECT:

Click on this button to disconnect the connection with the sensor hardware. The opened communication port becomes free again.



ACCEPT:

When you click on the ACCEPT button, the current communication settings are saved in the *L-LAS-LT-Scope.ini* file. When the *L-LAS-LT-Scope* software is started again, communication is established with the parameters saved in the *L-LAS-LT-Scope.ini* file.

STATUS MESSAGES – CONNECTION PROBLEMS

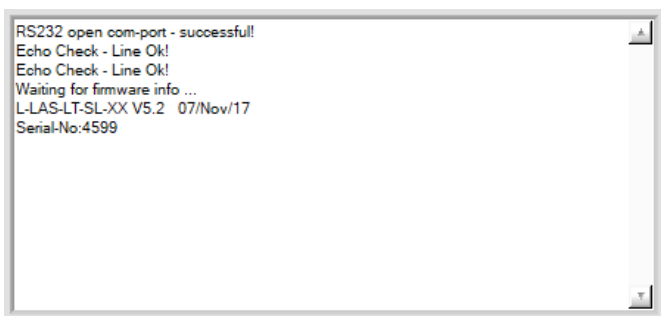

The serial connection between PC and *L-LAS-LT Control Unit* could not be established, or the connection is faulty.

In this case it should first be checked whether the *L-LAS-LT Control Unit* is connected to the power supply, and whether the serial interface cable is correctly connected to PC and *L-LAS-LT Control Unit*.

When the software is started it attempts to establish a connection to the *L-LAS-LT sensor* through the COM interface that was last used.

If connection could be established successfully, the current firmware version and the serial number of the sensor are displayed in the status text field.



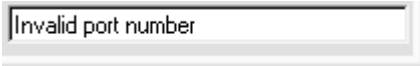

If there is an “Invalid port number” status message, the selected interface (e.g. COM2) is not available at your PC.



If there is a “Cannot open port” status message, the selected interface (e.g. COM2) may already be used by another device.



COMMUNICATION TYPE:

The type of data communication can be set in this function field:

RS232:

Data communication through the standard RS232 interface.



TCP/IP:

Data communication through a RS232-TCP/IP Ethernet converter module.

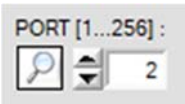

PORT [1...256]:

The number of the communication port can be set in this function field. Possible values are COM 1 to 255.

The communication port number can be found in the Windows® operating system under START/Control Panel/Device Manager.

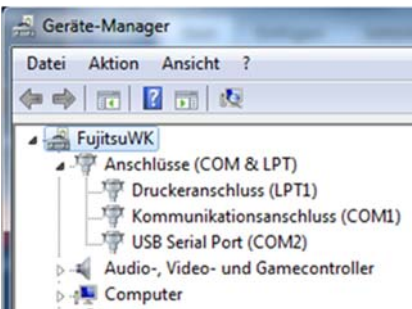

As an alternative the communication port numbers that are available on the PC can be searched by clicking on the magnifier symbol.

The available COM ports are displayed in the status text field.



BAUDRATE:

The baud rate of the serial interface can be set in this function field:

Possible values: 9600Baud, 19200Baud, 38400Baud, 57600Baud or 115200Baud. (Setting when delivered = 115200 Baud).



CHANGE BAUDRATE:

With a click on this button the baud rate of the serial interface at the sensor hardware is changed to the value selected in the SELECT-BAUDRATE list field. A corresponding status message will be displayed when the baud rate change at the sensor was successful.

The baud rate change only is performed in the volatile RAM memory of the *L-LAS-LT Control Unit*. If the baud rate should be changed permanently, the new baud rate value must be saved to the EEPROM by clicking on the [SEND] + [EEPROM] buttons!

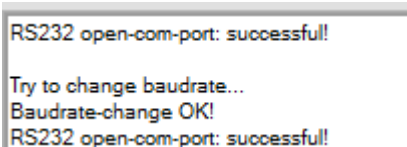

3.7.1 Data transfer through the external RS232 Ethernet adapter:

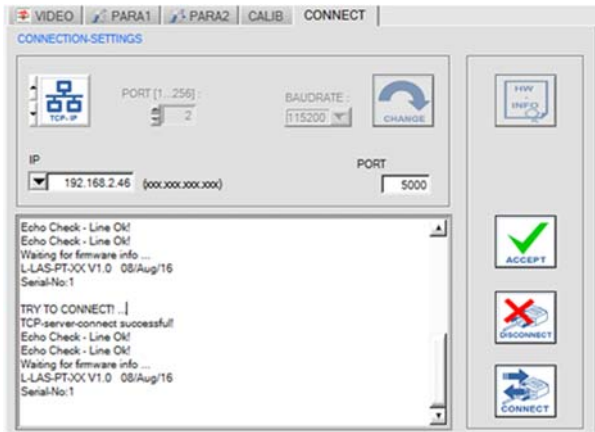

An RS232 to Ethernet adapter is needed if the sensor should communicate through a local network. With this adapter a connection to the sensor can be established using the TCP/IP protocol.

The network adapter converts the standard RS232 signals of the sensor and provides an interface for a LAN network. The RS232 interface can be operated with a baud rate of 11200Baud.

A software (*SensorFinder V1.1*) that is supplied with the adapter can be used to find the adapter in the network and to then configure it:



RS232 to Ethernet adapter: *cab-4/ETH-500*

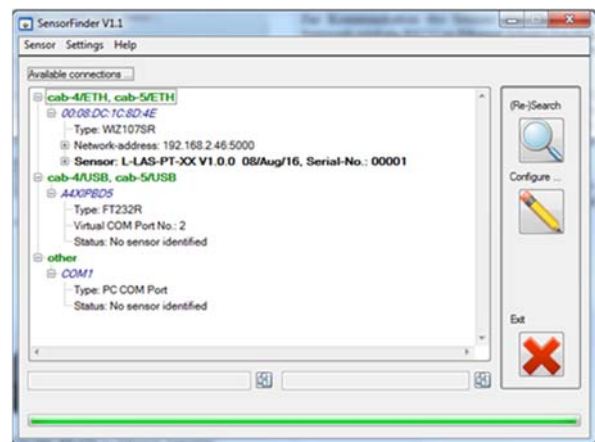

Software: *SensorFinder V1.1*



IP ADDRESS:

Input mask for entering the IP address.

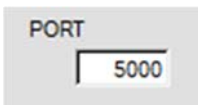

PORT NUMBER:

The **PORT NUMBER** for the network adapter is set to PORT:5000. This value must not be changed.



ACCEPT:

With a click on the ACCEPT SETTINGS button the current setting values of the *L-LAS-LT-Scope* PC software are saved in the *LT-Scope.ini* file. The popup window will then be closed. When the *L-LAS-LT-Scope* software is restarted, the parameters saved in the INI file will be loaded.

4 Working with the L-LAS-LT-Scope software

4.1 Setting the laser operating mode

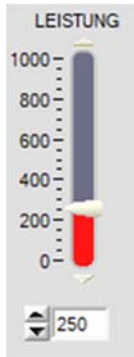
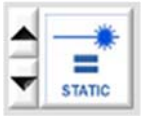

In case of static power setting the transmitter power must be set at the *L-LAS-LT Control Unit* in such a way that the maximum value of the video curve clearly lies above the detection threshold (= video threshold). The measurement values are calculated from the intersection points of the video curve with the green horizontal video threshold.

TRANSMITTER POWER too low:
 - No edges can be detected!

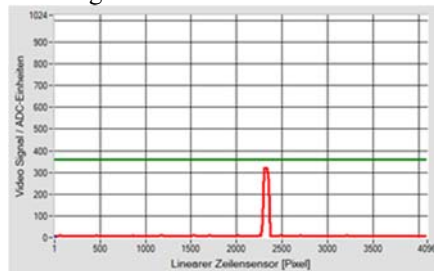

TRANSMITTER POWER OK:

- Edges can be detected, there is a valid measurement value!

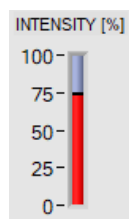
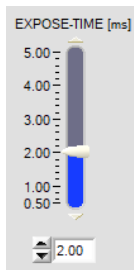
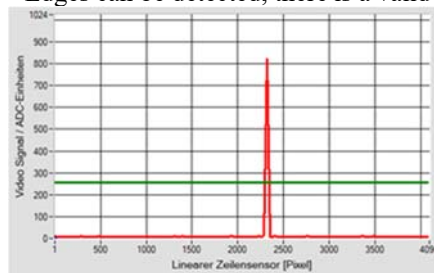

In case of dynamic power control the laser power must be set in such a way that the maximum value of the video curve lies between the control limits of 70% and 90% of the dynamic range.

With dark measuring objects it may be that the maximum possible laser power is no longer sufficient to generate the video peak. In such cases the exposure time at the line receiver can be increased. However, such an increase of the exposure time has the disadvantage that it reduces the sensor's switching frequency.

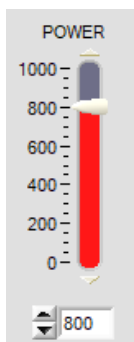

With dynamic exposure time control the exposure time at the line receiver is adapted until the maximum value of the video curve lies between the control limits of 70% and 90% of the dynamic range.

Long exposure times especially in case of dark measuring objects can be avoided by setting the laser power to a higher value before this mode is activated.

4.2 Aid for sensor adjustment, numeric and graphic display elements



When you click on the RUN button and then select the VIDEO button, the distance position of the sensors relative to the measuring object can be watched in the graphic display window. Because of the limited data transfer rate of the serial RS232 interface the graphic display window can only be updated every second.

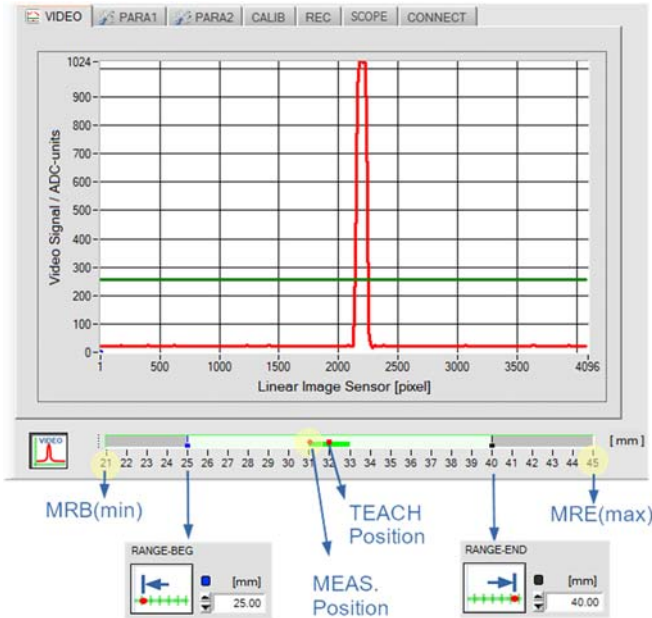

Under the video image there is a graphic display element that provides information about various settings.

The currently set evaluation range is represented by a turquoise area (50mm to 100mm). In this evaluation range the analog swing of 0-10V or 4-20mA is output at the *L-LAS-LT Control Unit*.

The respective object position in the evaluation range of the *L-LAS-LT Control Unit* is shown as a red circular graphic cursor.

The tolerance band around the teach value (red square cursor) is shown in light green color.

The outer edges of the evaluation range display represent the beginning and the end of the standard evaluation range.

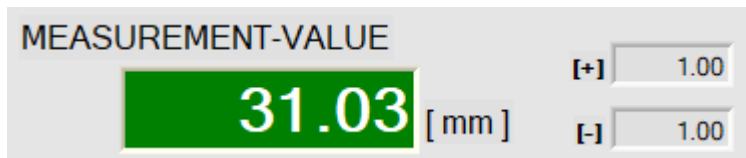

The current measurement value [mm] is shown in a separate numeric display field. The [+] [-] values of the tolerance band [mm] are shown in two additional display fields.

Slim-Line Series (SL-Type):



The current measurement value lies in the tolerance band.
(SWITCHPOINT LED lights up in green)



The current measurement value lies outside the tolerance band.
(SWITCHPOINT LED lights up in red)



The current measurement value lies outside the set evaluation range.
(SWITCHPOINT LED lights up in white)

Advanced-Line Series (AL-Type):



The current measurement value lies in the tolerance band.
(SWITCHPOINT LED lights up in green)



The current measurement value lies below the lower limit of the tolerance band.
(lower SWITCHPOINT LED lights up in red)



The current measurement value lies above the upper limit of the tolerance band.
(upper SWITCHPOINT LED lights up in red)

4.3 Teaching of evaluation range beginning (MRB) and end (MRE)

The sensors of the *L-LAS-LT series* allow the teaching of a partial range for evaluation within the standard evaluation range. The complete swing of the analog output U-OUT (0...10V) or of the current output I-OUT (4...20mA) can thus be fully used in this partial range. Evaluation range teaching can be performed both with the button at the housing and with digital input IN1/pin4/yellow (see chapter 5.4 and 5.5).



PROCEDURE FOR EVALUATION RANGE TEACHING:

When the L-LAS-LT Control Unit is turned on, the button at the housing is enabled for range teaching for 5 minutes. After range teaching this time starts anew. When these 5 minutes are over, the button will be locked for TEACHING; if another TEACH process should then be performed, the supply voltage must first be turned off / on. Through digital input IN1/pin4/yellow the TEACH process can be performed at any time from the PLC.

press button > 5sec

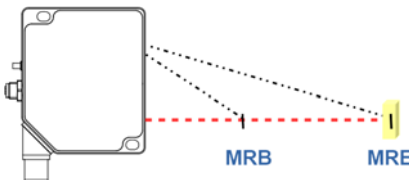
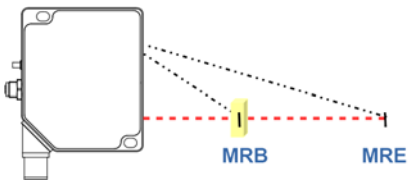

PROCEDURE FOR RANGE TEACHING:

1. Press the button for at least 5 seconds until the green OPERATION LED flashes in red!
(If the green OPERATION LED does not flash, the 5 minutes already are over)
2. Release the button.
3. Move the measuring object to the distance at which the sensor should output 0V or 4mA! If this distance should lie outside the standard evaluation range, the OPERATION LED will flash at a slower rate.
4. Press the button briefly. For confirmation the OPERATION LED will light up in red for 2 seconds and will then continue to flash.
5. Move the measuring object to the distance at which the sensor should output 10V or 20mA! If this distance should lie outside the standard evaluation range, the OPERATION LED will flash at a slower rate.
6. Press the button briefly. For confirmation the OPERATION LED will light up in red for 5 seconds and will then change back and continuously light up in green..

If one of the two teach limits should lie outside the standard evaluation range, or if the distance of the two limits was too small, the OPERATION LED instead of the 2nd confirmation flashes in red at a very fast rate for approx. 5 seconds. Teaching of the new evaluation range then was not completed! The second evaluation range position must then be taught anew by changing the distance and then briefly pressing the button.

As an alternative it also is possible to restore the standard evaluation range (see chapter 4.4).

If RANGE TEACHING is performed with the PLC through digital input IN1/pin4/yellow (see chapter 5.5), the above-described procedure also must be observed. As with teaching with the button, the OPERATION LED will flash in red for confirmation, and simultaneously with the LED status indication the alarm output OUT0/pin5/ will provide 0V (LED off) or +24VDC (LED red).

4.4 Restoring the standard evaluation range

Restoring of the standard evaluation range (factory settings) with the button at the housing only can be performed **within 5 minutes after the control unit has been turned on** or after a TEACH process!

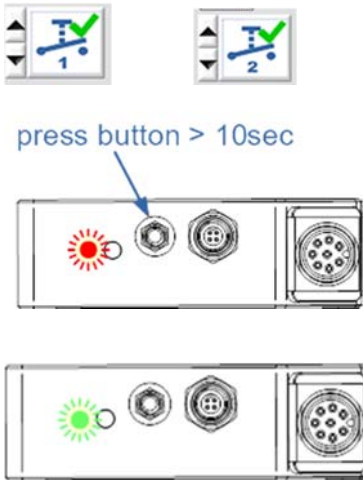

Please note:

The button at the housing must be enabled!

PROCEDURE:

1. Press the button for at least 5 seconds until the green OPERATION LED flashes in red!
2. **Do not release the button!**
After another 5 seconds the OPERATION LED will stop flashing.
3. After 10 seconds the OPERATION LED will continuously light up in white. You may then release the button.
When you have released the button the OPERATION LED will continuously light up in green. The standard evaluation range has been restored.

With the same procedure the standard evaluation range also can be restored with the PLC through digital input IN1/pin4. As with resetting with the button, the OPERATION LED will flash in red for confirmation, and simultaneously with the LED status indication the alarm output OUT0/pin5/ will provide 0V (LED off) or +24VDC (LED red). After 10 seconds the OPERATION LED will continuously light up in white. The standard evaluation range has been restored. The HIGH level at digital input IN1/pin4 can be removed.

SLIM-Line Type (SL)	MRB	MRE	REF	RESOLUTION	LASER CLASS
L-LAS-LT-30-SL-P (spot)	typ. 21mm	typ. 45mm	32.5mm	typ. 6µm	Laser class 1
L-LAS-LT-30-SL-L (line)	typ. 21mm	typ. 45mm	32.5mm	typ. 6µm	Laser class 1
L-LAS-LT-50-SL-P (spot)	typ. 32mm	typ. 70mm	50mm	typ. 10µm	Laser class 1
L-LAS-LT-50-SL-L (line)	typ. 32mm	typ. 70mm	50mm	typ. 10µm	Laser class 1
L-LAS-LT-80-SL-P (spot)	typ. 40mm	typ. 140mm	80mm	typ. 20µm	Laser class 1
L-LAS-LT-80-SL-L (line)	typ. 40mm	typ. 140mm	80mm	typ. 20µm	Laser class 1
L-LAS-LT-130-SL-P (spot)	typ. 50mm	typ. 200mm	125mm	typ. 40µm	Laser class 1
L-LAS-LT-130-SL-L (line)	typ. 50mm	typ. 200mm	125mm	typ. 40µm	Laser class 1
L-LAS-LT-180-SL-P (spot)	typ. 60mm	typ. 300mm	180mm	typ. 60µm	Laser class 1
L-LAS-LT-180-SL-L (line)	typ. 60mm	typ. 300mm	180mm	typ. 60µm	Laser class 2
L-LAS-LT-350-SL-P (spot)	typ. 90mm	typ. 600mm	350mm	typ. 150µm	Laser class 2
L-LAS-LT-350-SL-L (line)	typ. 90mm	typ. 600mm	350mm	typ. 150µm	Laser class 2
L-LAS-LT-600-SL-P (spot)	typ. 150mm	typ. 1000mm	600mm	typ. 250µm	Laser class 2
L-LAS-LT-600-SL-L (line)	typ. 150mm	typ. 1000mm	600mm	typ. 250µm	Laser class 2

Table1: Overview of standard evaluation ranges of the *L-LAS-LT-SL series*

ADVANCED-Line Type (AL)	MRB	MRE	REF	RESOLUTION	LASER CLASS
L-LAS-LT-20-AL	typ. 18mm	typ. 21.5mm	19.5mm	typ. 1µm	Laser class 1
L-LAS-LT-38-AL	typ. 32mm	typ. 48mm	40mm	typ. 5µm	Laser class 1
L-LAS-LT-50-AL	typ. 36mm	typ. 74mm	50mm	typ. 10µm	Laser class 1
L-LAS-LT-120-AL	typ. 60mm	typ. 180mm	120mm	typ. 30µm	Laser class 1
L-LAS-LT-165-AL	typ. 75mm	typ. 275mm	160mm	typ. 60µm	Laser class 2
L-LAS-LT-250-AL	typ. 60mm	typ. 500mm	250mm	typ. 250µm	Laser class 2

Table2: Overview of standard evaluation ranges of the *L-LAS-LT-AL series*

5 Annex

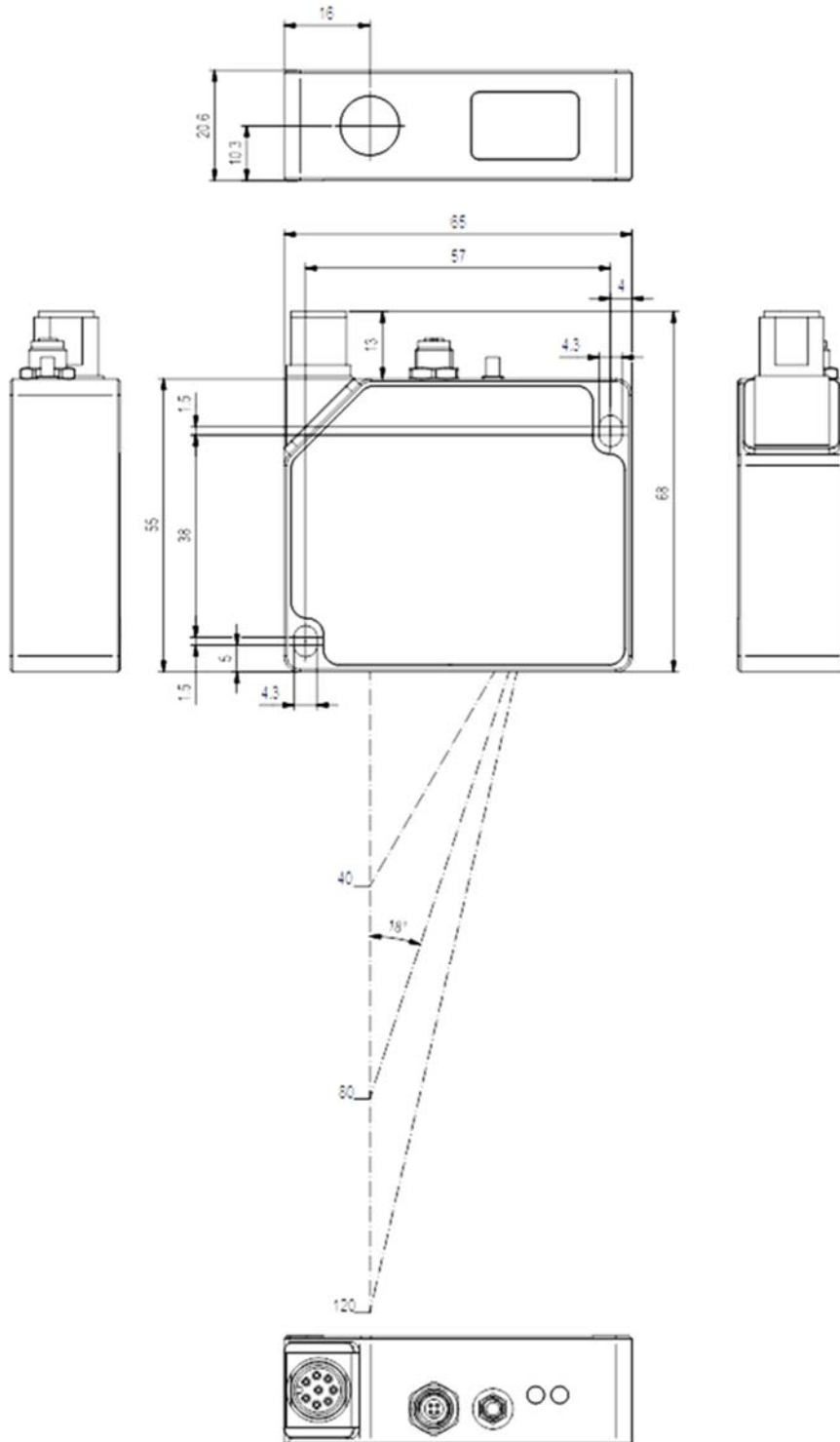

5.1 Dimensions / adjustment



All data in mm

The adjustment distance relative to the measuring object must be adapted to the standard evaluation range (see table 1).

5.2 Laser warning

LASER WARNING Laser Class 1	
<p>Applies to sensor type:</p> <p>L-LAS-LT-30-SL-P L-LAS-LT-30-SL-L L-LAS-LT-50-SL-P L-LAS-LT-50-SL-L L-LAS-LT-80-SL-P L-LAS-LT-80-SL-L L-LAS-LT-130-SL-P L-LAS-LT-130-SL-L L-LAS-LT-180-SL-P</p> <p>L-LAS-LT-20-AL L-LAS-LT-38-AL L-LAS-LT-50-AL L-LAS-LT-120-AL</p>	<p>Solid state laser, $\lambda=670$ nm, 0.4mW max. optical power, Laser Class 1 according to EN 60825-1.</p> <p>The use of these laser transmitters therefore requires no additional protective measures.</p> <div style="display: flex; justify-content: space-around; align-items: center;">  <div style="border: 2px solid black; padding: 5px; text-align: center;"> <p>CLASS 1 Laser Product IEC 60825-1: 2008-05 THIS LASER PRODUCT COMPLIES WITH 21 CFR 1040 AS APPLICABLE</p> </div> </div>
LASER WARNING Laser Class 2	
<p>Applies to sensor type:</p> <p>L-LAS-LT-180-SL-L L-LAS-LT-350-SL-P L-LAS-LT-350-SL-L L-LAS-LT-600-SL-P L-LAS-LT-600-SL-L</p> <p>L-LAS-LT-165-AL L-LAS-LT-250-AL</p>	<p>Solid state laser, $\lambda=670$ nm, 1mW max. optical power, Laser Class 2 according to EN 60825-1.</p> <p>The use of these laser transmitters therefore requires no additional protective measures.</p> <div style="display: flex; justify-content: space-around; align-items: center;">  <div style="border: 2px solid black; padding: 5px; text-align: center;"> <p>LASER RADIATION DO NOT STARE INTO THE BEAM CLASS II LASER PRODUCT</p> </div> </div>

5.3 Function of digital input IN0

The function of digital input IN0/pin3/green depends on the operating mode that is set in the EXT-IN0-MODE function field (PARAMETERS-1 tab):



The state of IN0 is displayed on the user interface by way of the IN0 LED.

When there is a HIGH level (+24VDC) the LED lights up in green.

A change of state only is refreshed if data transfer is active!



RUN



NO USE = CONTINUOUS OPERATION:

The control unit continuously evaluates the video images. The evaluation result continuously is provided at the digital outputs (OUT0, OUT1) and at the analog output.



TRIGG-IN0 L/H:

The current video image immediately after the LOW/HIGH edge is used for evaluation and is output.



TRIGG IN0 HIGH:

Video images only are evaluated when there is a HIGH level (+24VDC) at IN0/pin3.



LASER ON/OFF:

The laser transmitter can be turned on or off through the external trigger input IN0/pin3.

IN0 = 0V: LASER OFF

IN0 = +24VDC: LASER ON

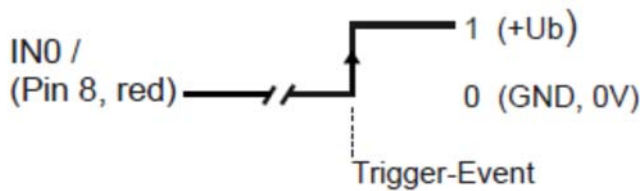

TRIGG-IN0 L/H:

External edge-controlled (LOW/HIGH) triggering of measurement value evaluation through digital input IN0.

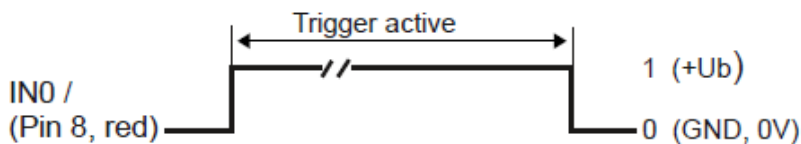

TRIGG-IN0 HIGH:

External triggering of measurement value evaluation through a HIGH level (+24VDC) at digital input IN0.

5.4 Function of digital input IN1

Digital input IN1/pin4/yellow of the L-LAS-LT Control Unit can be used for four different functions.

RESET function:

When a HIGH pulse of less than **750 ms** duration is applied, the RESET function is performed at the analog output of the *L-LAS-LT Control Unit*. This resets the current maximum and minimum values (drag pointer values).

This does not perform a hardware or software RESET!

When a RESET pulse is detected, the green OPERATION LED at the housing flashes briefly one time.

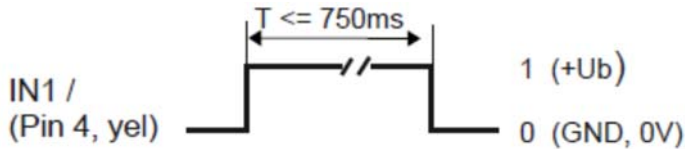

TEACH function:

When a HIGH pulse between **1.5s** and **4.0s** duration is applied, the current distance from the measuring object is saved as the TEACH POSITION at the *L-LAS-LT Control Unit*.

When a TEACH pulse is detected, the green OPERATION LED at the housing flashes briefly three times.

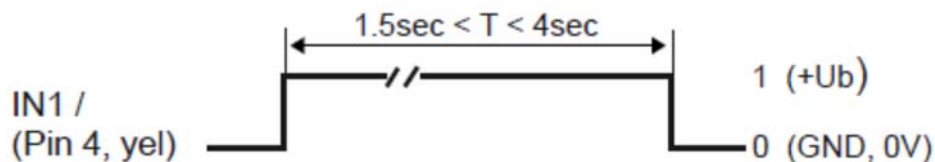

RANGE TEACH function:

When a HIGH pulse of more than **5s** duration is applied, the RANGE TEACH function is activated at the *L-LAS-LT Control Unit*.

When a RANGE TEACH pulse is detected, the OPERATION LED at the housing continuously flashes in red.

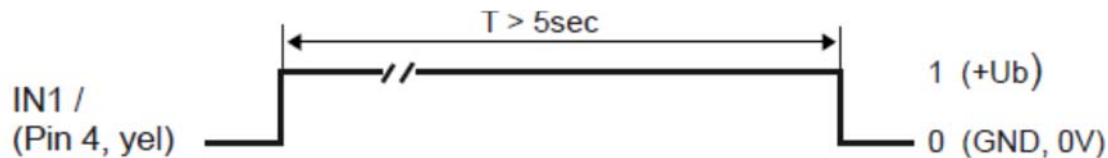

FACTORY SETTINGS:

When a HIGH pulse of more than **10s** duration is applied, the FACTORY SETTINGS for the EVALUATION RANGE are restored from the EEPROM to the RAM memory of the *L-LAS-LT Control Unit*. When this pulse is detected, the OPERATION LED at the housing lights up in white for 5 seconds and then changes back to operating state green.

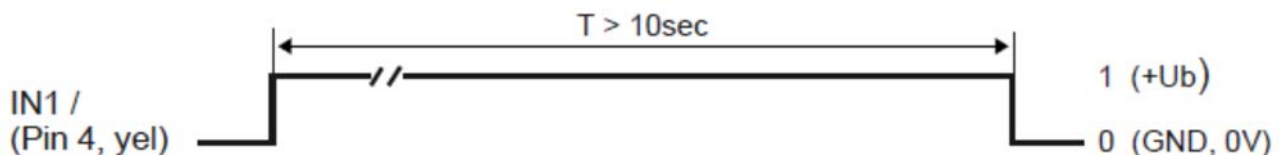

5.5 Function of the hardware button at the housing

This function is available only for *L-LAS-LT-SL series* hardware!

The button at the housing of the *L-LAS-LT-SL Control Unit* can be used for four functions:

1	RESET = Resetting of maximum or minimum value at the analog output: (button pressed briefly < 0.75s)
2	TEACH = Current position = switching threshold: (1.5s < button pressed < 4s)
3	RANGE-TEACH = Teach evaluation range beginning and end: (5s < button pressed long < 10s)
4	FACTORY SETTINGS = Resetting of the evaluation range: (10s < button pressed long < 15s)

Please note that functions (3) and (4) only can be performed within 5 minutes after the *L-LAS-LT Control Unit* has been turned on. When these 5 minutes are over, only the RESET (1) function and the TEACH (2) function can still be performed with the button.

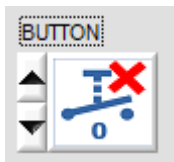

PLEASE NOTE!

If the hardware button at the housing is deactivated in the software, none of the above functions can be performed with the button!

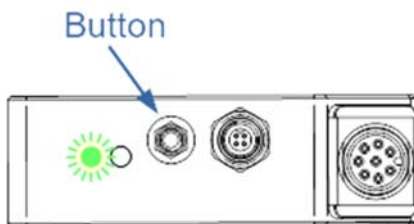

RESET function: **1**

If the button is pressed briefly ($t < 0.75s$) the current maximum and minimum values at the analog output (drag pointer values) will be reset. When a RESET pulse is detected the green LED at the housing flashes briefly 1x.



TEACH function: **2**

If the button is pressed for a longer time ($1.5s < t < 4s$) the current measurement value will be saved to the RAM memory as a teach value. When the teach function is successfully completed the green LED flashes briefly 3x.

RANGE-TEACH function: 3

With the button at the sensor housing the range-teach function can be performed in five steps.

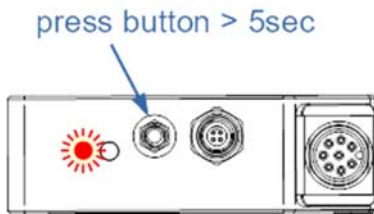

LED
flashes red



► **START THE RANGE-TEACH FUNCTION:**

If the button is pressed for a long time ($5s < t < 10s$) the range-teach function will be activated.

When the range-teach function has been activated the OPERATION LED at the housing flashes in red every second.

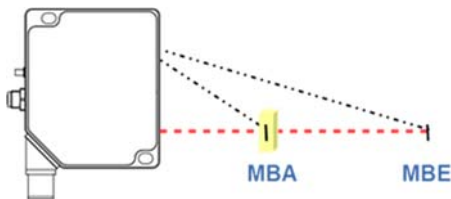

►► **POSITIONING OF EVAL- RANGE BEGINNING**

(Measuring object to evaluation range beginning – minimum measuring distance)

If the distance falls below the standard evaluation range beginning the red LED will flash at a slower rate.

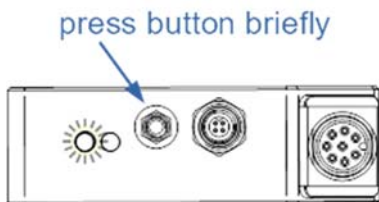

LED
flashes red



►►► **TEACH EVAL-RANGE BEGINNING:**

When the measuring object is positioned at the new evaluation range beginning, press the button briefly to teach the new eval-range beginning.

The LED will remain red for 2 seconds, and then will again flash in red every second.

The analog output U-OUT changes to 0V, the current output I-OUT changes to 4mA.

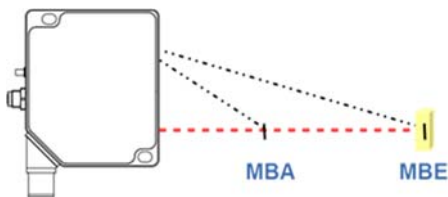

►►►► **POSITIONING OF EVAL-RANGE END**

(Measuring object to evaluation range end – maximum measuring distance)

If the distance rises above the standard evaluation range end the red LED will flash at a slower rate.

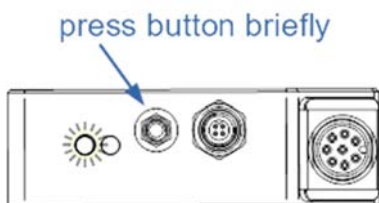

LED
flashes red



►►►►► **TEACH EVAL-RANGE END:**

When the measuring object is positioned at the new evaluation range end, press the button briefly to teach the new eval-range end.

TEACH FUNCTION COMPLETED:

The LED remains red for 5 seconds, and then it continuously lights up in green.

The analog output U-OUT changes to 10V, the current output I-OUT changes to 20mA.



5.6 Connectors

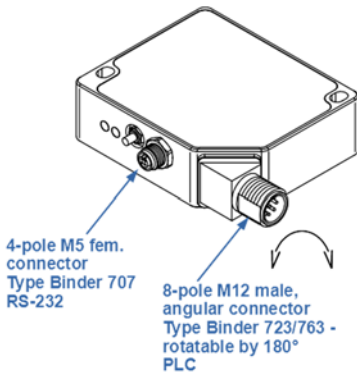

SLIM-LINE (SL) series:

There are two female/male connectors at the housing of the *L-LAS-LT-SL Control Unit*.

An 8-pole M12 connector of type Binder 723/763 in angular design is used to connect the sensor to the PLC. The angular connector can be rotated by 180°.

A 4-pole M5 female connector of type Binder 707 is used to connect the serial RS232 interface.

RS232 connection to the PC (L-LAS-LT-SL series and L-LAS-LT-AL series)

4-pole M5 female connector type Binder 707

Connecting cable: **cab-las4/PC-(length)** (length 2m or 5m, cable sheath: PUR) or **cab-4/USB-(length)** (length 2m or 5m, cable sheath: PUR) or **cab-4/ETH-500** (length 0.5m, cable sheath: PUR)

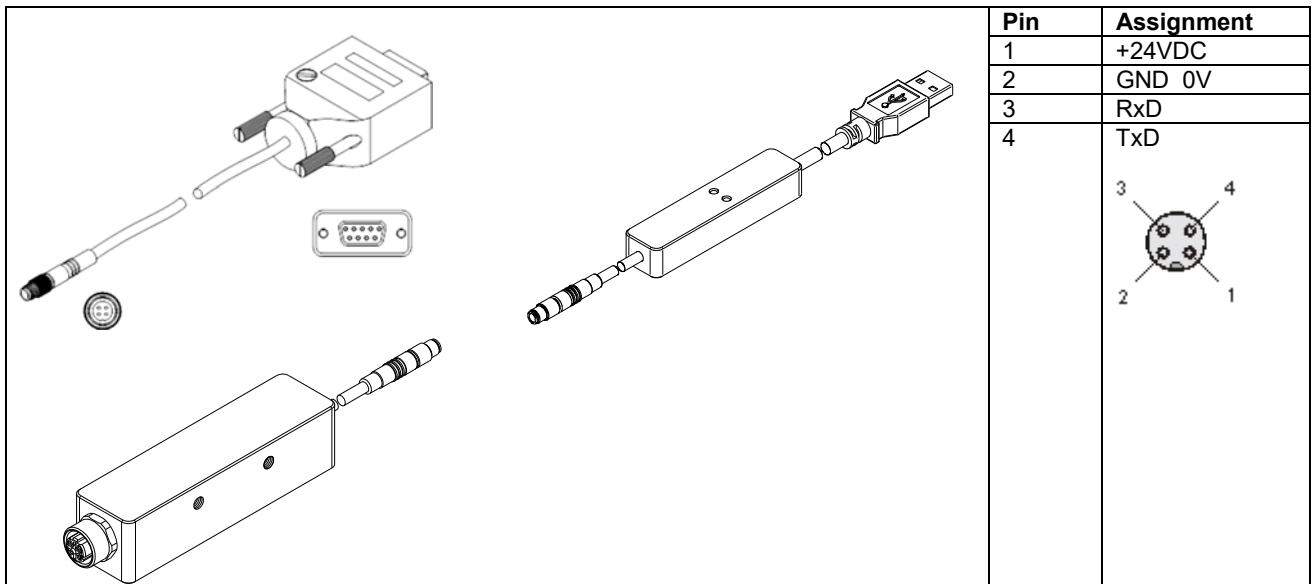

Interface to PLC / power supply (L-LAS-LT-SL series):

8-pole M12 connector type Binder 723/763

Connecting cable: **cab-M12/8-g-(length)-shd** (length 2m or 5m, cable sheath: PUR)

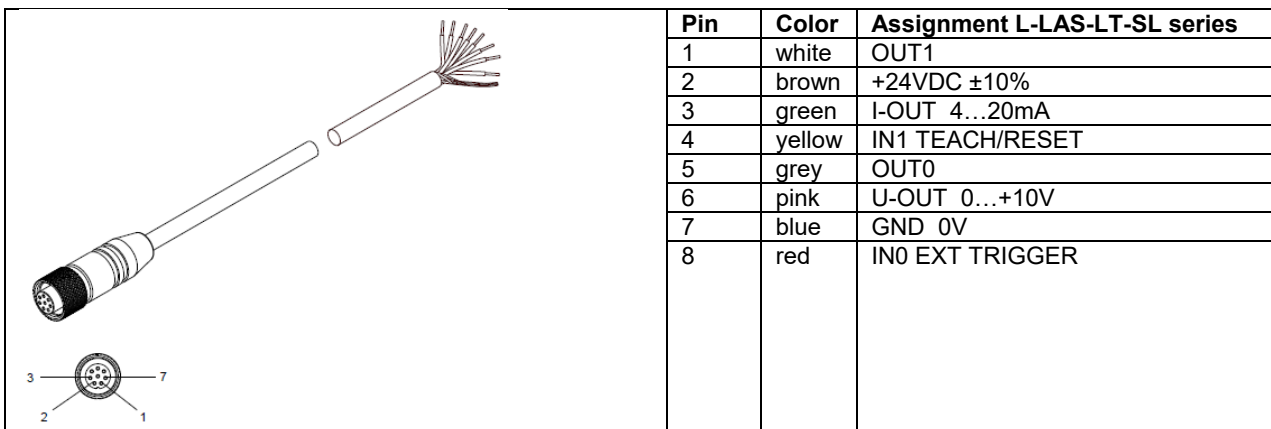



ADVANCED-LINE (AL) series:

There are two female/male connectors at the housing of the *L-LAS-LT-AL Control Unit*.

An 8-pole M9 connector of type Binder 712 is used to connect the sensor to the PLC.

A 4-pole M5 female connector of type Binder 707 is used to connect the serial RS232 interface.

Interface to PLC / power supply (L-LAS-LT-AL series):

8-pole M9 female connector type Binder 712

Connecting cable: cab-las8/SPS (length 2m, cable jacket: PUR)

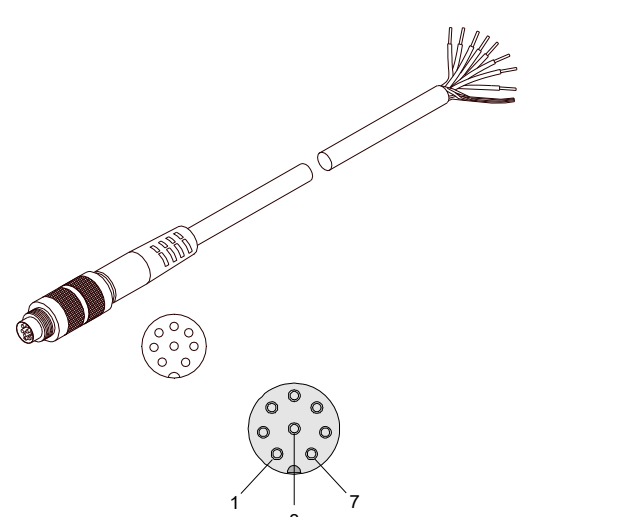

Pin	Color	Assignment L-LAS-LT-AL series
1	white	0V (GND)
2	brown	+24 VDC ± 10%
3	green	IN0
4	yellow	IN1
5	grey	OUT0 (-)
6	pink	OUT1 (+)
7	blue	OUT2 (OK)
8	red	U-OUT (0...+10V) or I-OUT (4 ... 20mA) (selectable by software-switch)

5.7 RS232 interface protocol

- Standard RS232 serial interface, no hardware handshake
- 3-wire connection: GND, TXD, RXD
- Speed: 9600 Baud, 19200 Baud, 38400 Baud, 57600 Baud or 115200 Baud
- 8 data bits
- NO parity bit
- 1 STOP bit
- Binary mode.

METHOD:

The *L-LAS-LT* sensor always behaves passively. Data exchange therefore is initiated by the PC (or PLC). The PC sends a data package ("frame") either with or without appended data, to which the *L-LAS-LT* sensor responds with a frame that matches the request. The data package comprises a **HEADER** and the optional **DATA**

HEADER

- 1. Byte** : Synchronisation byte <SYNC> (85_{dez} = 0x55_{hex})
- 2. Byte** : Order byte <ORDER>
3. Byte : Argument <ARG LO>
4. Byte : Argument <ARG HI>
5. Byte : Data length <LEN LO>
6. Byte : Data length <LEN HI>
7. Byte : Checksum Header <CRC8 HEAD>
8. Byte : Checksum Data <CRC8 DATA>

The first byte is a synchronisation byte and always is 85_{dez} (55_{hex}). The second byte is the so-called order byte <ORDER>, it determines the action that should be performed (send data, save data, etc.).

A 16-bit value <ARG> follows as the third and fourth byte. Depending on the order the argument is assigned a corresponding value. The fifth and sixth byte again form a 16-bit value <LEN>. This value states the number of appended data bytes. Without appended data <LEN=0>, the maximum data length is 512 bytes <LEN=512>. The seventh byte is formed with the CRC8 checksum over all data bytes.

The eight byte is the CRC8 checksum for the header and is formed from bytes 1 up to and incl. 7.

The header always has a total length of 8 bytes. The complete frame may contain between 8 and 520 bytes.

Byte1 Header	Byte2 Header	Byte3 Header	Byte4 Header	Byte5 Header	Byte6 Header	Byte7 Header	Byte8 Header	Byte9 Data	Byte10 Data	...	Byte n+7 Data	Byte n+8 Data
0x55	<ORDER>	<ARG> (lo byte)	<ARG> (hi byte)	<LEN> (lo byte)	<LEN> (hi byte)	CRC8 (Data)	CRC8 (Header)	Data1 (lo byte)	Data1 (hi byte)	...	Data n/2 (lo byte)	Data n/2 (hi byte)

<ORDER>	Meaning of the 2.nd byte <order>:	ORDER-TABLE
0	NOP	no operation
1	Send parameter from PC to <i>L-LAS-LT</i> -RAM	PC ⇒ <i>L-LAS-LT</i> -RAM
2	Get parameter from <i>L-LAS-LT</i> -RAM	<i>L-LAS-LT</i> -RAM ⇒ PC
3	Send parameter from PC to <i>L-LAS-LT</i> EEPROM	PC ⇒ <i>L-LAS-LT</i> -EEPROM
4	Get parameter from <i>L-LAS-LT</i> EEPROM	<i>L-LAS-LT</i> -EEPROM ⇒ PC
5	Echo check: Get echo from <i>L-LAS-LT</i> sensor	first word=0x00AA=170dec
6	Activate teach at <i>L-LAS-LT</i> sensor, save to RAM	PC ⇒ <i>L-LAS-LT</i>
7	Get firmware version info from <i>L-LAS-LT</i> sensor	<i>L-LAS-LT</i> ⇒ PC
8	Get measurement values from <i>L-LAS-LT</i> sensor	<i>L-LAS-LT</i>-RAM ⇒ PC
9	Get video buffer info from <i>L-LAS-LT</i> sensor	<i>L-LAS-LT</i> -RAM ⇒ PC
11	Reset max/min values at the <i>L-LAS-LT</i> analog output	PC ⇒ <i>L-LAS-LT</i> -RAM
18	Get data recorder values from <i>L-LAS-LT</i> sensor	<i>L-LAS-LT</i> -RAM ⇒ PC
190	Change RS232 baud rate of the <i>L-LAS-LT Control Unit</i> (RAM)	PC ⇒ <i>L-LAS-LT</i> -RAM

CRC8 CHECKSUMMEN BERECHNUNG:

The so-called "Cyclic Redundancy Check" or CRC is used to verify data integrity. This algorithm makes it possible to detect individual bit errors, missing bytes, and faulty frames. For this purpose a value - the so-called checksum - is calculated over the data (bytes) to be checked and is transmitted together with the data package. Calculation is performed according to an exactly specified method based on a generator polynomial. The length of the checksum is 8 bit (= 1 byte). The generator polynomial is:

$$X^8+X^5+X^4+X^0$$

To verify the data after they have been received, CRC calculation is performed once again. If the sent and the newly calculated CRC values are identical, the data are without error.

The following pseudo code can be used for checksum calculation:

calcCRC8 (data[], table[])

Input: data[], n data of unsigned 8bit
table[], 256 table entries of unsigned 8bit
Output: crc8, unsigned 8bit

```

crc8 := AAhex
for I := 1 to n do
    idx := crc8 EXOR data[ i ]
    crc8 := table[ idx ]
endfor
return crc8

```

table[]

0	94	188	226	97	63	221	131	194	156	126	32	163	253	31	65
157	195	33	127	252	162	64	30	95	1	227	189	62	96	130	220
35	125	159	193	66	28	254	160	225	191	93	3	128	222	60	98
190	224	2	92	223	129	99	61	124	34	192	158	29	67	161	255
70	24	250	164	39	121	155	197	132	218	56	102	229	187	89	7
219	133	103	57	186	228	6	88	25	71	165	251	120	38	196	154
101	59	217	135	4	90	184	230	167	249	27	69	198	152	122	36
248	166	68	26	153	199	37	123	58	100	134	216	91	5	231	185
140	210	48	110	237	179	81	15	78	16	242	172	47	113	147	205
17	79	173	243	112	46	204	146	211	141	111	49	178	236	14	80
175	241	19	77	206	144	114	44	109	51	209	143	12	82	176	238
50	108	142	208	83	13	239	177	240	174	76	18	145	207	45	115
202	148	118	40	171	245	23	73	8	86	180	234	105	55	213	139
87	9	235	181	54	104	138	212	149	203	41	119	244	170	72	22
233	183	85	11	136	214	52	106	43	117	151	201	74	20	246	168
116	42	200	150	21	75	169	247	182	232	10	84	215	137	107	53

5.7.1 Parameter set format

The sensors of the *L-LAS-LT-xx series* operate with the following 42 parameters that must be sent to the sensor or read from the sensor as appended data in the stated sequence:

DATA-FRAME: <parameter-set>		
Para	Meaning	Comment
1	POWER	Laser intensity (0 ... 1000)
2	INTEGRATION-TIME	Integration time 0.3ms ... 10ms (= 300 ... 10000)
3	POWER-MODE	Laser power mode: (0 = STATIC), (1=DYNAMIC), (2=DYN-EXPOSE)
4	VIDEO-THRESHOLD	Video-threshold [%] (0 ... 100)
5	SEARCH-DIRECTION	Edge search: (0:= LEFT_TO_RIGHT, 1:=RIGHT_TO_LEFT)
6	WORK-MODE *)	Working mode: (0:=DIFFUSE-REF., 1:=DIRECT-REFLEXION)
7	EVAL-MODE *)	Evaluation mode (0=L-EDGE, 1=R-EDGE, 2=WIDHTH, 3=CENTER)
8	BACKGROUND-MODE	Background compensation (0:=OFF, 1:=ON)
9	EVALUATE-PROGRAM	Program number to evaluate (0,1,2 or 3)
10	E-BEG	Evaluation start-pixel (1 ... E_END - 1)
11	E-END	Evaluation end -pixel (E_BEG+1 ... SUBPIXEL)
12	TEACH-VALUE	Teach-value (1 ... SUBPIXEL)
13	PIX-TOLUP	Upper-tolerance (0 ... SUBPIXEL/2)
14	PIX-TOLLO	Lower-tolerance (0 ... SUBPIXEL/2)
15/16	UM-BEGIN	Range begin in [microns] Attention long-variable 32 bit
17/18	UM-END	Range end in [microns] Attention long variable 32 bit
19/20	UM-TEACH	Teach-value in [microns] Attention long variable 32 bit
21/22	UM-TOLUP	Upper tolerance in [microns] Attention long variable 32 bit
23/24	UM-TOLLO	Lower tolerance in [microns] Attention long variable 32 bit
25	AVERAGE	Average-setting (1, 2, 4, 5, 16, 32, 64,128, 256, 512 or 1024)
26	POLARITY	Polarity for OUT0, OUT1 und OUT2 (0=DIRECT, 1=INVERT)
27	DOUT-MODE	Mode for digital outputs (0, 1 or 2)
28	OP-MODE	CMOS-operation-mode (0=FULL_RES, 1=HALF_RES/DOUBLE-SPEED)
29	HW-MODE	Enable/disable button at housing (DISABLE=0, ENABLE=1)
30	AOUT-MODE	Mode for analog output (0:=UOUT, 1:=I-OUT 4..20mA)
31	ANA-MODE	Analog-mode (0=DIRECT,1=MAXIMA,2=MINIMA,3=MAX_MIN)
32	ANA-ZOOM	Analog-output-zoom-mode: output (0=DIRECT, 1=ZOOMx1, 2=ZOOMx2, 3=ZOOMx4, 4=ZOOMx8, 5=ZOOMx16, 6=WIDHTH, 10V)
33	RS232-MODE	RS232 mode: (0=STAT,1=IN0-L/H,2=IN0-HI[6-byte])
34	RS232-BAUDRATE	Baudrate: (0=9600,1=19200,2=38400,3=57600,4=115200) baud
35	VIDEO-SMOOTH	Smooth video signal over (1,2,4,6,8) pixel
36	EXT-TRIGG-MODE	External-trigger-mode:(0=CONTINUOUS, 1=IN0 L/H, 2=IN0 HI, 3=SAVE-VTHD, 4=OUTPUT-WIDHTH, 5=LIGHT-ON)
37	FREE-USE	Free-use
38	FREE-USE	Free-use
39	FREE-USE	Free-use
40	FREE-USE	Free-use
41	FREE-USE	Free-use
42	FREE-USE	Free-use

*) not used in firmware version 5.2

5.7.2 RS232 data transfer examples

< ORDER = 5 > : ECHO-CHECK, READ LINE OK from sensor.

DATA FRAME PC → Sensor (8 Bytes)

Byte1 Header	Byte2 Header	Byte3 Header	Byte4 Header	Byte5 Header	Byte6 Header	Byte7 Header	Byte8 Header
0x55	<order>	<ARG> (lo byte)	<ARG> (hi byte)	<LEN> (lo byte)	<LEN> (hi byte)	CRC8 (Data)	CRC8 (Header)
85	5	0	0	0	0	170	60
ARG=0				LEN=0			

DATA FRAME Sensor → PC (8 Bytes)

Byte1 Header	Byte2 Header	Byte3 Header	Byte4 Header	Byte5 Header	Byte6 Header	Byte7 Header	Byte8 Header
0x55	<order>	<ARG> (lo byte)	<ARG> (hi byte)	<LEN> (lo byte)	<LEN> (hi byte)	CRC8 (Data)	CRC8 (Header)
85	5	170	0	0	0	170	178
ARG=170				LEN=0			

Serial – number of sensor = <ARG> value

< ORDER = 7 > : Read FIRMWARE-VERSION STRING from sensor.

Byte1 Header	Byte2 Header	Byte3 Header	Byte4 Header	Byte5 Header	Byte6 Header	Byte7 Header	Byte8 Header
0x55	<order>	<ARG> (lo byte)	<ARG> (hi byte)	<LEN> (lo byte)	<LEN> (hi byte)	CRC8 (Data)	CRC8 (Header)
85 (dec)	7	0	0	0	0	170	82
ARG=0				LEN=0			

DATA FRAME Sensor → PC (8 + 72) Bytes

Byte1 Header	Byte2 Header	Byte3 Header	Byte4 Header	Byte5 Header	Byte6 Header	Byte7 Header	Byte8 Header	Byte9 Data	Byte10 Data	Byte11 Data	Byte12 Data
0x55	<order>	<ARG> (lo byte)	<ARG> (hi byte)	<LEN> (lo byte)	<LEN> (hi byte)	CRC8 (Data)	CRC8 (Header)	ASCII	ASCII	ASCII	ASCII
85 (dec)	7	1	2	72	0	252	82	L	-	L	A
ARG=12 (Ser.-No)				LEN=72							

Byte13 Data	Byte14 Data	Byte15 Data	Byte16 Data	Byte17 Data	Byte18 Data	Byte19 Data	Byte20 Data	Byte21 Data	Byte22 Data	Byte23 Data	Byte24 Data
ASCII	ASCII	ASCII	ASCII	ASCII	ASCII	ASCII	ASCII	ASCII	ASCII	ASCII	ASCII
S	-	P	T	6	4	-	X	X		.	V

Byte25 Data	Byte26 Data	Byte27 Data	Byte28 Data	Byte29 Data	Byte30 Data	Byte31 Data	Byte32 Data	Byte33 Data	Byte34 Data	Byte35 Data	Byte36 Data
ASCII	ASCII	ASCII	ASCII	ASCII	ASCII	ASCII	ASCII	ASCII	ASCII	ASCII	ASCII
5	.	2	.	0			2	5	/	A	u

Byte37 Data	Byte38 Data	Byte39 Data	Byte40 Data	Byte41 Data	Byte42 Data	Byte43 Data	Byte44 Data	Byte45 Data	Byte46 Data	Byte47 Data	Byte48 Data
ASCII	ASCII	ASCII	ASCII	ASCII	ASCII	ASCII	ASCII	ASCII	ASCII	ASCII	ASCII
g	/	1	7								

Byte49 Data	Byte50 Data	Byte51 Data	Byte52 Data	Byte53 Data	Byte54 Data	Byte55 Data	Byte56 Data	Byte57 Data	Byte58 Data	Byte59 Data	Byte60 Data
ASCII	ASCII	ASCII	ASCII	ASCII	ASCII	ASCII	ASCII	ASCII	ASCII	ASCII	ASCII

Byte61 Data	Byte62 Data	Byte63 Data	Byte64 Data	Byte65 Data	Byte66 Data	Byte67 Data	Byte68 Data	Byte69 Data	Byte70 Data	Byte71 Data	Byte72 Data
ASCII	ASCII	ASCII	ASCII	ASCII	ASCII	ASCII	ASCII	ASCII	ASCII	ASCII	ASCII

Byte73 Data	Byte74 Data	Byte75 Data	Byte76 Data	Byte77 Data	Byte78 Data	Byte79 Data	Byte80 Data
ASCII	ASCII	ASCII	ASCII	ASCII	ASCII	ASCII	ASCII

< ORDER = 1 > : SEND PARAMETER-SET TO RAM of the sensor

DATA FRAME PC → Sensor (8 + 84) Bytes

Byte1 Header	Byte2 Header	Byte3 Header	Byte4 Header	Byte5 Header	Byte6 Header	Byte7 Header	Byte8 Header	Byte9 Data	Byte10 Data	Byte11 Data	Byte12 Data
0x55	<order>	<ARG> (lo byte)	<ARG> (hi byte)	<LEN> (lo byte)	<LEN> (hi byte)	CRC8 (Data)	CRC8 (Header)	Para1 (lo byte)	Para1 (hi byte)	Para2 (lo byte)	Para2 (hi byte)
85 (dec)	1	0	0	42	0	tdb	81	144	1	244	1
ARG=0				LEN=42				POWER=400		INT-TIME=500	

Byte13 Data	Byte14 Data	Byte15 Data	Byte16 Data	Byte17 Data	Byte18 Data	Byte19 Data	Byte20 Data	Byte21 Data	Byte22 Data	Byte23 Data	Byte24 Data
Para3	Para3	Para4	Para4	Para5	Para5	Para6	Para6	Para7	Para7	Para8	Para8
0	0	25	0	0	0	0	0	0	0	0	0
P-MODE=0		VTHD=25		SDIR=0		W-MODE=0		E-MODE=0		BG--MODE=0	

Byte25 Data	Byte26 Data	Byte27 Data	Byte28 Data	Byte29 Data	Byte30 Data	Byte31 Data	Byte32 Data	Byte33 Data	Byte34 Data	Byte35 Data	Byte36 Data
Para9	Para9	Para10	Para10	Para11	Para11	Para12	Para12	Para13	Para13	Para14	Para14
0	0	1	0	0	16	0	8	100	0	100	0
E-PROG=0		E-BEG=1		E-END=4096		TEACH=2048		TOLUP=100		TOLLO=100	

Byte37 Data	Byte38 Data	Byte39 Data	Byte40 Data	Byte41 Data	Byte42 Data	Byte43 Data	Byte44 Data	Byte45 Data	Byte46 Data	Byte47 Data	Byte48 Data
Para15	Para15	Para16	Para16	Para17	Para17	Para18	Para18	Para19	Para19	Para20	Para20
112	17	1	0	0	0	0	0	0	0	0	0
UM-RBEG=70000				UM-REND=240000				UM-TEACH=180000			

Byte49 Data	Byte50 Data	Byte51 Data	Byte52 Data	Byte53 Data	Byte54 Data	Byte55 Data	Byte56 Data	Byte57 Data	Byte58 Data	Byte59 Data	Byte60 Data
Para21	Para21	Para22	Para22	Para23	Para23	Para24	Para24	Para25	Para25	Para26	Para26
0	0	0	0	0	0	0	0	2	0	0	0
UM-TOLUP=10000				UM-TOLLO=10000				AVERAGE=2		POLARITY=0	

Byte61 Data	Byte62 Data	Byte63 Data	Byte64 Data	Byte65 Data	Byte66 Data	Byte67 Data	Byte68 Data	Byte69 Data	Byte70 Data	Byte71 Data	Byte72 Data
Para27	Para27	Para28	Para28	Para29	Para29	Para30	Para30	Para31	Para31	Para32	Para32
2	0	0	0	1	0	0	0	0	0	0	0
DOUT-MODE=2		OP-MODE=0		HW-MODE=1		AOUT-MODE=0		ANA-MODE=0		ANA-ZOOM=0	

Byte73 Data	Byte74 Data	Byte75 Data	Byte76 Data	Byte77 Data	Byte78 Data	Byte79 Data	Byte80 Data	Byte81 Data	Byte82 Data	Byte83 Data	Byte84 Data
Para33	Para33	Para34	Para34	Para35	Para35	Para36	Para36	Para37	Para37	Para38	Para38
0	0	4	0	100	0	0	0	0	0	0	0
RS232-MODE=0		RS232-BAUD=4		VIDEO-SMOOTH=2		EXT-TRG=0		FREE-USE=0		FREE-USE=0	

Byte85 Data	Byte86 Data	Byte87 Data	Byte88 Data	Byte89 Data	Byte90 Data	Byte91 Data	Byte92 Data
Para39	Para39	Para40	Para40	Para41	Para41	Para42	Para42
0	0	0	0	0	0	0	0
FREE-USE=0		FREE-USE=0		FREE-USE=0		FREE-USE=0	

DATA FRAME Sensor → PC (8 Byte)

Byte1 Header	Byte2 Header	Byte3 Header	Byte4 Header	Byte5 Header	Byte6 Header	Byte7 Header	Byte8 Header
0x55	<order>	<ARG> (lo byte)	<ARG> (hi byte)	<LEN> (lo byte)	<LEN> (hi byte)	CRC8 (Data)	CRC8 (Header)
85 (dec)	1	0	0	0	0	170	81
ARG=0				LEN=0			

< ORDER = 2 > : READ PARAMETER-SET FROM RAM of the sensor

DATA FRAME PC → Sensor (8 Bytes)

Byte1 Header	Byte2 Header	Byte3 Header	Byte4 Header	Byte5 Header	Byte6 Header	Byte7 Header	Byte8 Header
0x55	<order>	<ARG> (lo byte)	<ARG> (hi byte)	<LEN> (lo byte)	<LEN> (hi byte)	CRC8 (Data)	CRC8 (Header)
85 (dec)	2	0	0	0	0	170	185
ARG=0				LEN=0			

DATA FRAME Sensor → PC (8+84) Bytes

Byte1 Header	Byte2 Header	Byte3 Header	Byte4 Header	Byte5 Header	Byte6 Header	Byte7 Header	Byte8 Header	Byte9 Data	Byte10 Data	Byte11 Data	Byte12 Data
0x55	<order>	<ARG> (lo byte)	<ARG> (hi byte)	<LEN> (lo byte)	<LEN> (hi byte)	CRC8 (Data)	CRC8 (Header)	Para1 (lo byte)	Para1 (hi byte)	Para2 (lo byte)	Para2 (hi byte)
85 (dec)	2	0	0	42	0	xxx	185	144	1	244	1
ARG=0				LEN=42				POWER=400		INT-TIME=500	

The data-block is similar to < ORDER = 1 >:



Byte85 Data	Byte86 Data	Byte87 Data	Byte88 Data	Byte89 Data	Byte90 Data	Byte91 Data	Byte92 Data
Para39	Para39	Para40	Para40	Para41	Para41	Para42	Para42
0	0	0	0	0	0	0	0
FREE-USE=0		FREE-USE=0		FREE-USE=0		FREE-USE=0	

< ORDER = 6 > : INITIATE TEACH-PROCEDURE at sensor (RAM)

The actual measurement value is set as new TEACH-IN value

DATA FRAME PC → Sensor (8-Bytes + 32)Bytes

PEAK-NO-A and PEAK-NO-B values are used for detecting the valid teach-in-peak
 E-MODE and W-MODE values are currently not used!

BYTES : Will be refreshed by TEACH procedure!

Byte1 Header	Byte2 Header	Byte3 Header	Byte4 Header	Byte5 Header	Byte6 Header	Byte7 Header	Byte8 Header	Byte9 Data	Byte10 Data	Byte11 Data	Byte12 Data
0x55	<order>	<ARG> (lo byte)	<ARG> (hi byte)	<LEN> (lo byte)	<LEN> (hi byte)	CRC8 (Data)	CRC8 (Header)	Word1 (lo byte)	Word1 (hi byte)	Word2 (lo byte)	Word2 (hi byte)
85 (dec)	6	0	0	32	0	252	247	1	0	1	0
ARG = 0				LEN = 32				PEAK-NO-A = 1		PEAK-NO-B = 1	

Byte13 Data	Byte14 Data	Byte15 Data	Byte16 Data	Byte17 Data	Byte18 Data	Byte19 Data	Byte20 Data	Byte21 Data	Byte22 Data	Byte23 Data	Byte24 Data
Word3	Word3	Word4	Word4	Word5	Word5	Word6	Word6	Word7	Word7	Word8	Word8
0	0	0	0	0	0	0	0	0	0	0	0
E-MODE = 0		W-MODE = 0		TVAL = 2048		TOLUP = 200		TOLLO = 200		EDCNT = 0	

Byte25 Data	Byte26 Data	Byte27 Data	Byte28 Data	Byte29 Data	Byte30 Data	Byte31 Data	Byte32 Data	Byte33 Data	Byte34 Data	Byte35 Data	Byte36 Data
Word9	Word9	Word10	Word10	Word11	Word11	Word12	Word12	Word13	Word13	Word14	Word14
1	0	2	0	32	191	2	0	39	16	0	0
PEAK-POSA = 3396		PEAK-POSB = 3469		UM-TEACH = 180229				UM-TOLUP = 100000			

Byte37 Data	Byte38 Data	Byte39 Data	Byte40 Data
Word 15	Word15	Word16	Word16
16	39	0	0
UM-TOLLO = 10000			

DATA FRAME Sensor → PC (8 + 32) Bytes

New TEACH-VECTOR is sent back in **refreshed-BYTES**

Byte1 Header	Byte2 Header	Byte3 Header	Byte4 Header	Byte5 Header	Byte6 Header	Byte7 Header	Byte8 Header	Byte9 Data	Byte10 Data	Byte11 Data	Byte12 Data
0x55	<order>	<ARG> (lo byte)	<ARG> (hi byte)	<LEN> (lo byte)	<LEN> (hi byte)	CRC8 (Data)	CRC8 (Header)	Word1 (lo byte)	Word1 (hi byte)	Word2 (lo byte)	Word2 (hi byte)
85 (dec)	6	1	0	32	0	150	236	1	0	1	0
ARG = 1 = OK				LEN = 32				PEAK-NO-A = 1		PEAK-NO-B = 1	

Byte13 Data	Byte14 Data	Byte15 Data	Byte16 Data	Byte17 Data	Byte18 Data	Byte19 Data	Byte20 Data	Byte21 Data	Byte22 Data	Byte23 Data	Byte24 Data
Word3	Word3	Word4	Word4	Word5	Word5	Word6	Word6	Word7	Word7	Word8	Word8
0	0	0	0	128	9	200	0	200	0	2	0
E-MODE = 0		W-MODE = 0		TVAL = 2432		TOLUP = 200		TOLLO = 200		EDCNT = 2	

Byte25 Data	Byte26 Data	Byte27 Data	Byte28 Data	Byte29 Data	Byte30 Data	Byte31 Data	Byte32 Data	Byte33 Data	Byte34 Data	Byte35 Data	Byte36 Data
Word9	Word9	Word10	Word10	Word11	Word11	Word12	Word12	Word13	Word13	Word14	Word14
68	13	141	13	7	192	2	0	16	39	0	0
PEAK-POSA = 3396		PEAK-POSB = 3469		UM-TEACH = 180229				UM-TOLUP = 100000			

Byte37 Data	Byte38 Data	Byte39 Data	Byte40 Data
Word 15	Word15	Word16	Word16
16	39	0	0
UM-TOLLO = 10000			

< ORDER = 8 > : READ MEASUREMENT DATA from sensor

DATA FRAME PC → Sensor (8 Bytes)

Byte1 Header	Byte2 Header	Byte3 Header	Byte4 Header	Byte5 Header	Byte6 Header	Byte7 Header	Byte8 Header
0x55	<order>	<ARG> (lo byte)	<ARG> (hi byte)	<LEN> (lo byte)	<LEN> (hi byte)	CRC8 (Data)	CRC8 (Header)
85 (dec)	8	0	0	0	0	170	118
ARG=0				LEN=0			

DATA FRAME Sensor → PC (8 + 52) Bytes

Byte1 Header	Byte2 Header	Byte3 Header	Byte4 Header	Byte5 Header	Byte6 Header	Byte7 Header	Byte8 Header	Byte9 Data	Byte10 Data	Byte11 Data	Byte12 Data
0x55	<order>	<ARG> (lo byte)	<ARG> (hi byte)	<LEN> (lo byte)	<LEN> (hi byte)	CRC8 (Data)	CRC8 (Header)	Raw1 (lo byte)	Raw1 (hi byte)	Raw2 (lo byte)	Raw2 (hi byte)
85 (dec)	8	0	0	52	0	89	118	68	13	141	13
ARG=0				LEN=52				E_LEFT = 3396		E_RIGHT = 3469	

Byte13 Data	Byte14 Data	Byte15 Data	Byte16 Data	Byte17 Data	Byte18 Data	Byte19 Data	Byte20 Data	Byte21 Data	Byte22 Data	Byte23 Data	Byte24 Data
Raw3	Raw3	Raw4	Raw4	Raw5	Raw5	Raw6	Raw6	Raw7	Raw7	Raw8	Raw8
78	8	2	0	7	192	2	0	0	8	11	0
M_VAL = 2126		EDGE_CNT = 2		UM_VALUE = 180229				UM_MAX = 184733			

Byte25 Data	Byte26 Data	Byte27 Data	Byte28 Data	Byte29 Data	Byte30 Data	Byte31 Data	Byte32 Data	Byte33 Data	Byte34 Data	Byte35 Data	Byte36 Data
Raw9	Raw9	Raw10	Raw10	Raw11	Raw11	Raw12	Raw12	Raw13	Raw13	Raw14	Raw14
0	0	0	0	7	192	2	0	22	17	1	0
UM_MIN = 0				UM_TEACH = 180229				UM_RBEG = 70000			

Byte37 Data	Byte38 Data	Byte39 Data	Byte40 Data	Byte41 Data	Byte42 Data	Byte43 Data	Byte44 Data	Byte45 Data	Byte46 Data	Byte47 Data	Byte48 Data
Raw15	Raw15	Raw16	Raw16	Raw17	Raw17	Raw18	Raw18	Raw19	Raw19	Raw20	Raw20
192	69	4	0	104	13	0	0	250	3	0	0
UM_REND = 280000				TVAL = 3432		INSTATE=0		VIDEOMAX = 1018		DYNPOW=0	

Byte49 Data	Byte50 Data	Byte51 Data	Byte52 Data	Byte53 Data	Byte54 Data	Byte55 Data	Byte56 Data	Byte57 Data	Byte58 Data	Byte59 Data	Byte60 Data
Raw21	Raw22	Raw23	Raw24	Raw25	Raw26	Raw27	Raw27	Raw28	Raw28	Raw29	Raw29
235	1	0	0	214	3	0	0	0	0	0	0
DYN_TIME=491		STATE=0		SCANTIME=982				RAW20=0		RAW21 = 0	

-raw	0x0070C9B8	raw_struct
raw.Lval	3396	unsigned short
raw.Rval	3469	unsigned short
raw.Mval	2126	unsigned short
raw.edcnt	2	unsigned short
raw.umVAL	180229	long int
raw.umMAX	184733	long int
raw.umMIN	0	long int
raw.umTEACH	180229	long int
raw.umRBEG	70000	long int
raw.umREND	280000	long int
raw.Tval	3432	unsigned short
raw.instate	0	unsigned short
raw.videoMax	1018	unsigned short
raw.dynpow	0	unsigned short
raw.dyntime	491	unsigned short
raw.state	0	short
raw.scntime	982	long int
raw.raw20	0	unsigned short
raw.raw21	0	unsigned short

< ORDER = 11 > : RESET MAX/MIN VALUE OF ANALOG-OUTPUT at sensor

DATA FRAME PC → Sensor (8 Bytes)

Byte1 Header	Byte2 Header	Byte3 Header	Byte4 Header	Byte5 Header	Byte6 Header	Byte7 Header	Byte8 Header
0x55	<order>	<ARG> (lo byte)	<ARG> (hi byte)	<LEN> (lo byte)	<LEN> (hi byte)	CRC8 (Data)	CRC8 (Header)
85 (dec)	11	0	0	0	0	170	47
		ARG=0		LEN=0			

DATA FRAME Sensor → PC (8 Bytes)

Byte1 Header	Byte2 Header	Byte3 Header	Byte4 Header	Byte5 Header	Byte6 Header	Byte7 Header	Byte8 Header
0x55	<order>	<ARG> (lo byte)	<ARG> (hi byte)	<LEN> (lo byte)	<LEN> (hi byte)	CRC8 (Data)	CRC8 (Header)
85 (dec)	190	0	0	0	0	170	47
		ARG=0		LEN=0			

< ORDER = 16 > : START/STOP RANGE-TEACH-IN PROCEDURE at sensor

DATA FRAME PC → Sensor (8-Bytes)

Byte1 Header	Byte2 Header	Byte3 Header	Byte4 Header	Byte5 Header	Byte6 Header	Byte7 Header	Byte8 Header
0x55	<order>	<ARG> (lo byte)	<ARG> (hi byte)	<LEN> (lo byte)	<LEN> (hi byte)	CRC8 (Data)	CRC8 (Header)
85 (dec)	16	3	0	0	0	170	194
		ARG=3		LEN=0			

STEP1: <ARG> = 3 = START RANGE-TEACH-IN (backup old settings!)

STEP2: <ARG> = 4 = TEACH-IN RANGE-BEGIN

STEP3: <ARG> = 5 = TEACH-IN RANGE-END

STEP4: <ARG> = 6 = STOP RANGE-TEACH-IN

EXIT: <ARG> = 7 = BREAK RANGE-TEACH-IN (old settings are restored !)

DATA FRAME Sensor → PC (8 + 4) Bytes

STEP1: Start new RANGE-TEACH-IN:

Byte1 Header	Byte2 Header	Byte3 Header	Byte4 Header	Byte5 Header	Byte6 Header	Byte7 Header	Byte8 Header	Byte9 Data	Byte10 Data	Byte11 Data	Byte12 Data
0x55	<order>	<ARG> (lo byte)	<ARG> (hi byte)	<LEN> (lo byte)	<LEN> (hi byte)	CRC8 (Data)	CRC8 (Header)	Data1 (lo byte)	Data1 (hi byte)	Data2 (lo byte)	Data2 (hi byte)
85 (dec)	16	3	0	4	0	xx	118	22	17	1	0
		ARG=3		LEN=4		DATA = 3					

STEP2: New UM-RANGE-BEGIN-VALUE is sent back in DATA-BYTES

Byte1 Header	Byte2 Header	Byte3 Header	Byte4 Header	Byte5 Header	Byte6 Header	Byte7 Header	Byte8 Header	Byte9 Data	Byte10 Data	Byte11 Data	Byte12 Data
0x55	<order>	<ARG> (lo byte)	<ARG> (hi byte)	<LEN> (lo byte)	<LEN> (hi byte)	CRC8 (Data)	CRC8 (Header)	Data1 (lo byte)	Data1 (hi byte)	Data2 (lo byte)	Data2 (hi byte)
85 (dec)	16	4	0	4	0	xx	118	22	17	1	0
		ARG=4		LEN=4		UM-RANGE-BEG = 70000					

STEP3: New UM-RANGE-END-VALUE is sent back in DATA-BYTES

Byte1 Header	Byte2 Header	Byte3 Header	Byte4 Header	Byte5 Header	Byte6 Header	Byte7 Header	Byte8 Header	Byte9 Data	Byte10 Data	Byte11 Data	Byte12 Data
0x55	<order>	<ARG> (lo byte)	<ARG> (hi byte)	<LEN> (lo byte)	<LEN> (hi byte)	CRC8 (Data)	CRC8 (Header)	Data1 (lo byte)	Data1 (hi byte)	Data2 (lo byte)	Data2 (hi byte)
85 (dec)	16	5	0	4	0	xx	118	192	69	4	0
		ARG=5		LEN=4		UM-RANGE-END = 280000					

STEP4: STOP RANGE-TEACH-IN:

Byte1 Header	Byte2 Header	Byte3 Header	Byte4 Header	Byte5 Header	Byte6 Header	Byte7 Header	Byte8 Header	Byte9 Data	Byte10 Data	Byte11 Data	Byte12 Data
0x55	<order>	<ARG> (lo byte)	<ARG> (hi byte)	<LEN> (lo byte)	<LEN> (hi byte)	CRC8 (Data)	CRC8 (Header)	Data1 (lo byte)	Data1 (hi byte)	Data2 (lo byte)	Data2 (hi byte)
85 (dec)	16	6	0	4	0	xx	118	22	17	1	0
		ARG=6		LEN=4		DATA = 6					

< ORDER = 24 > : READ CALIBRATION HEADER FROM RAM of the sensor

DATA FRAME PC → Sensor

Byte1 Header	Byte2 Header	Byte3 Header	Byte4 Header	Byte5 Header	Byte6 Header	Byte7 Header	Byte8 Header
0x55	<order>	<ARG> (lo byte)	<ARG> (hi byte)	<LEN> (lo byte)	<LEN> (hi byte)	CRC8 (Data)	CRC8 (Header)
85 (dec)	24	0	0	0	0	170	45
ARG=0				LEN=0			

DATA FRAME Sensor → PC

Byte1 Header	Byte2 Header	Byte3 Header	Byte4 Header	Byte5 Header	Byte6 Header	Byte7 Header	Byte8 Header	Byte9 Data	Byte10 Data	Byte11 Data	Byte12 Data
0x55	<order>	<ARG> (lo byte)	<ARG> (hi byte)	<LEN> (lo byte)	<LEN> (hi byte)	CRC8 (Data)	CRC8 (Header)	Para1 (lo byte)	Para1 (hi byte)	Para2 (lo byte)	Para2 (hi byte)
85 (dec)	24	0	0	24	0	xx	45	52	56	12	0
ARG=0				LEN=24				HWTYPE=800820			

Byte13 Data	Byte14 Data	Byte15 Data	Byte16 Data	Byte17 Data	Byte18 Data	Byte19 Data	Byte20 Data	Byte21 Data	Byte22 Data	Byte23 Data	Byte24 Data
Para3	Para3	Para4	Para4	Para5	Para5	Para6	Para6	Para7	Para7	Para8	Para8
180	10	1	0	0	8	0	0	31	27	1	0
SERNO=2740		XFDIV=1		XFSIZE=2048		CALFREE=0		UMSLOPEx16384=72479			

Byte25 Data	Byte26 Data	Byte27 Data	Byte28 Data	Byte29 Data	Byte30 Data	Byte31 Data	Byte32 Data
Para9	Para9	Para10	Para10	Para11	Para11	Para12	Para12
204	121	0	0	200	70	0	0
UMOFFSETL=31180				UMRANGE=18120			

<pre>cal ├── cal.hwType ├── cal.serNo ├── cal.xfDivisor ├── cal.xfSize ├── cal.calib5 ├── cal.umSlope ├── cal.umOffset └── cal.umRange</pre>	<pre>0x00510EE4 800820 2740 1 2048 0 72479 31180 18120</pre>	<pre>calib_struct unsigned int unsigned short unsigned short unsigned short unsigned short unsigned int unsigned int unsigned int</pre>
--	--	---

< ORDER = 190 > : CHANGE BAUDRATE at sensor (RAM)

DATA FRAME PC → Sensor

Byte1 Header	Byte2 Header	Byte3 Header	Byte4 Header	Byte5 Header	Byte6 Header	Byte7 Header	Byte8 Header
0x55	<order>	<ARG> (lo byte)	<ARG> (hi byte)	<LEN> (lo byte)	<LEN> (hi byte)	CRC8 (Data)	CRC8 (Header)
85 (dec)	190	1	0	0	0	170	14
		ARG=1		LEN=0			

New baud rate is set by <ARG> value:

ARG=0: baud rate = 9600

ARG=1: baud rate = 19200

ARG=2: baud rate = 38400

ARG=3: baud rate = 57600

ARG=4: baud rate = 115200

DATA FRAME Sensor → PC

Byte1 Header	Byte2 Header	Byte3 Header	Byte4 Header	Byte5 Header	Byte6 Header	Byte7 Header	Byte8 Header
0x55	<order>	<ARG> (lo byte)	<ARG> (hi byte)	<LEN> (lo byte)	<LEN> (hi byte)	CRC8 (Data)	CRC8 (Header)
85 (dec)	190	0	0	0	0	170	195
		ARG=0		LEN=0			

< ORDER = 9 > : GET VIDEO-DATA INFORMATION of sensor

ATTENTION: Only 256 pixel of the CMOS line-sensor are transferred!

The <ARG> value determines the source of the VIDEO-DATA-INFORMATION

ARG = 0 : CMOS-VIDEO-RAM-DATA

DATA FRAME PC → Sensor

Byte1 Header	Byte2 Header	Byte3 Header	Byte4 Header	Byte5 Header	Byte6 Header	Byte7 Header	Byte8 Header
0x55	<order>	<ARG> (lo byte)	<ARG> (hi byte)	<LEN> (lo byte)	<LEN> (hi byte)	CRC8 (Data)	CRC8 (Header)
85 (dec)	9	0	0	0	0	170	185
ARG=0				LEN=0			

DATA FRAME Sensor → PC

Byte1 Header	Byte2 Header	Byte3 Header	Byte4 Header	Byte5 Header	Byte6 Header	Byte7 Header	Byte8 Header	Byte9 Data	Byte10 Data	Byte11 Data	Byte12 Data
0x55	<order>	<ARG> (lo byte)	<ARG> (hi byte)	<LEN> (lo byte)	<LEN> (hi byte)	CRC8 (Data)	CRC8 (Header)	Para1 (lo byte)	Para1 (hi byte)	Para2 (lo byte)	Para2 (hi byte)
85 (dec)	9	0	0	0	1	xxx	185	200	0	220	0
ARG=0				LEN=256				PIX1=200		PIX2=220	

Byte13 Data	Byte14 Data	Byte15 Data	Byte16 Data	Byte17 Data	Byte18 Data	Byte19 Data	Byte20 Data	Byte21 Data	Byte22 Data	Byte23 Data	Byte24 Data
Para3	Para3	Para4	Para4	Para5	Para5	Para6	Para6	Para7	Para7	Para8	Para8
240	0	0	1	44	1	124	1	0	2	88	2
PIX3=240			PIX4=256			PIX5=300			PIX6=380		

Byte25 Data	Byte26 Data	Byte27 Data	Byte28 Data	Byte29 Data	Byte30 Data	Byte31 Data	Byte32 Data	Byte33 Data	Byte34 Data	Byte35 Data	Byte36 Data
Para9	Para9	Para10	Para10	Para11	Para11	Para12	Para12	Para13	Para13	Para14	Para14
168	2	170	2	188	2	188	2	198	2	208	2
PIX9=680			PIX10=682			PIX11=700			PIX12=700		

Byte37 Data	Byte38 Data	Byte39 Data	Byte40 Data	Byte41 Data	Byte42 Data	Byte43 Data	Byte44 Data	Byte45 Data	Byte46 Data	Byte47 Data	Byte48 Data
Para15	Para15	Para16	Para16	Para17	Para17	Para18	Para18	Para19	Para19	Para20	Para20
34	3	32	3	32	3	22	3	19	3	20	3
PIX15=802			PIX16=800			PIX17=800			PIX18=790		

●
●
●

Byte49 Data	Byte50 Data	Byte51 Data	Byte52 Data	Byte53 Data	Byte54 Data	Byte55 Data	Byte56 Data	Byte57 Data	Byte58 Data	Byte59 Data	Byte60 Data
Para251	Para251	Para252	Para252	Para253	Para253	Para254	Para254	Para255	Para255	Para256	Para256
124	1	44	1	0	1	240	0	220	0	200	0
PIX251=380			PIX252=300			PIX253=256			PIX254=240		